

# VS-GSWG

## Swing Gate Operator

### Installation Guide

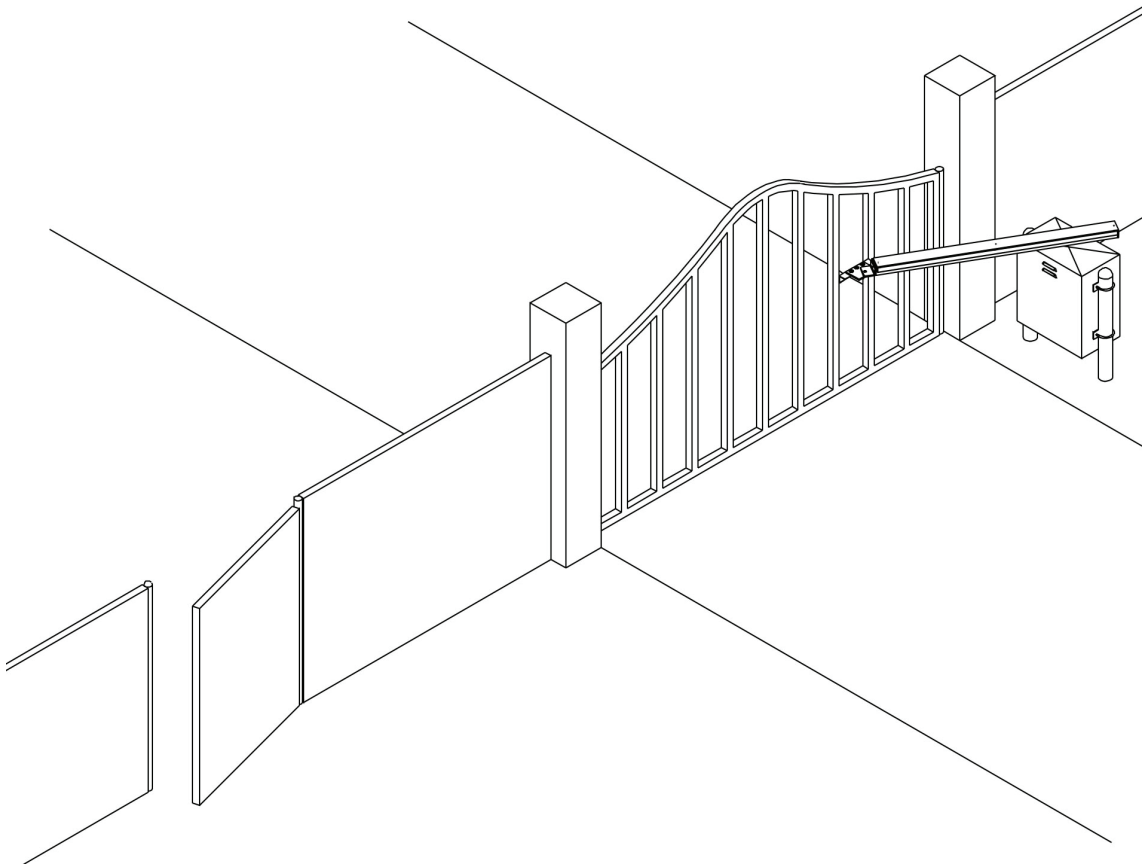

Operator models contained in this manual  
conform to UL325 standard for use in  
Class I, II, III, and IV applications

**Linear**<sup>®</sup>  
*Building On Innovation.*

USA & Canada (800) 421-1587 & (800) 392-0123  
(760) 438-7000 - Toll Free FAX (800) 468-1340  
[www.linearcorp.com](http://www.linearcorp.com)

# Table of Contents

<b>Pre-installation Information</b> . . . . .	1	Reverse Loop . . . . .	22
Before You Begin . . . . .	1	Shadow/Reset Loop . . . . .	22
Always Check the Gate's Action . . . . .	1	<b>Operation Indications</b> . . . . .	22
Gate Operator Classifications . . . . .	1	Power-up Display . . . . .	22
Approved Obstruction Detection Devices . . . . .	1	Idle Condition . . . . .	22
<b>Safety Information and Warnings</b> . . . . .	1	Last Gate Position/Condition . . . . .	22
Regulatory Warnings . . . . .	1	Pre-start Delay . . . . .	22
<b>Wiring Specifications</b> . . . . .	2	Reverse Delay . . . . .	22
AC Power Wiring . . . . .	2	Run Timer . . . . .	22
DC Control and Accessory Wiring . . . . .	2	<b>Error Indications</b> . . . . .	23
<b>Mounting Pad Installation</b> . . . . .	3	Entrapment . . . . .	23
Gate Preparation . . . . .	3	COMM LINK Connection Failure . . . . .	23
Mounting Specifications . . . . .	3	MGT Obstacle Transmitter Trouble . . . . .	23
<b>Operator Preparation</b> . . . . .	4	Maximum Run Time Exceeded . . . . .	23
Vent Plug Installation . . . . .	4	How to Order Replacement Parts . . . . .	24
<b>Gate Arm Installation</b> . . . . .	4	<b>Troubleshooting</b> . . . . .	24
Gate Arm Assembly . . . . .	4	Contacting Technical Support . . . . .	24
<b>Operator Setup</b> . . . . .	5	Operator fails to start . . . . .	24
Controller Access . . . . .	5	Motor operates, but gate does not move . . . . .	24
AC Power Connection . . . . .	5	Motor sounds like it is working harder than normal . . . . .	24
Earth Ground . . . . .	5	Limit switch getting out of time . . . . .	24
Open and Close Limit Adjustment . . . . .	6	Gate stopping part way open or closed . . . . .	24
Limit Nuts Rough Adjustment . . . . .	6	Gate staying open with automatic system . . . . .	24
Limit Nuts Fine Adjustment . . . . .	6	<b>Preventative Maintenance</b> . . . . .	25
Setting Speeds using LSO-2 & LSC-2 . . . . .	6	General . . . . .	25
Torque Limiter Adjustment . . . . .	7	Lubrication . . . . .	25
<b>Controller Features</b> . . . . .	8	6-Month Preventative Maintenance . . . . .	25
<b>Indicator Descriptions</b> . . . . .	9	<b>FCC Notice</b> . . . . .	25
<b>Terminal Descriptions</b> . . . . .	10	<b>Model VS-GSWG Exploded View</b> . . . . .	26
<b>Operator Accessory Connections</b> . . . . .	11	<b>Controller Parts List</b> . . . . .	28
<b>Basic Controller Programming</b> . . . . .	12	<b>Variable Speed Drive Programming</b> . . . . .	29
Programming Overview . . . . .	12	Programming the Hitachi Inverter . . . . .	29
Entering Programming Mode . . . . .	12	<b>Gate Arm Assembly Parts List</b> . . . . .	30
Exiting Programming Mode . . . . .	12	<b>Gate Operator Installation Checklist</b> . . . . .	32
Programming Keystrokes . . . . .	12		
Left or Right Hand Operation . . . . .	12		
Dual Gate Enable . . . . .	12		
Auto Close Timer . . . . .	12		
Run Alarm and Pre-start Alarm . . . . .	13		
Maximum Open Direction Current Setting . . . . .	13		
Maximum Close Direction Current Setting . . . . .	13		
<b>Advanced Controller Programming</b> . . . . .	14		
Entering Advanced Programming Mode . . . . .	14		
Maximum Run Time . . . . .	14		
Single Button Input Setup . . . . .	14		
Stagger Mode . . . . .	14		
Stagger Delay Time . . . . .	14		
Auxiliary Relay Mode . . . . .	15		
Reverse Delay Time . . . . .	15		
Brake Delay Time . . . . .	15		
Constant Pressure Mode . . . . .	15		
Shadow Loop Open Prevention . . . . .	15		
Reset Cycle Count . . . . .	16		
Maintenance Alert Trigger . . . . .	16		
Mid-travel Stop Position . . . . .	16		
Anti-tailgate Enable . . . . .	16		
Radio Enable . . . . .	16		
Antenna Installation . . . . .	16		
Radio Transmitter Learn . . . . .	17		
Radio Transmitter Delete . . . . .	17		
MGT Obstacle Transmitter Learn . . . . .	17		
MGT Obstacle Transmitter Delete . . . . .	17		
Motor Type Selection . . . . .	17		
Reset Controller to Factory Defaults . . . . .	17		
<b>Loop Layout Illustration</b> . . . . .	18		
<b>Safety Edge Layout Illustration</b> . . . . .	19		
<b>Photoeye Installation Illustration</b> . . . . .	20		
<b>Dual Gate Installations</b> . . . . .	21		
<b>Optional In-Cabinet Heater</b> . . . . .	21		
<b>Gate Operation</b> . . . . .	22		
Open Button . . . . .	22		
Close Button . . . . .	22		
Stop Button . . . . .	22		
Single Input . . . . .	22		
Fire Department Input . . . . .	22		
Open Input . . . . .	22		
Open Obstruction . . . . .	22		
Close Obstruction . . . . .	22		
Reverse Input . . . . .	22		
Open Loop . . . . .	22		

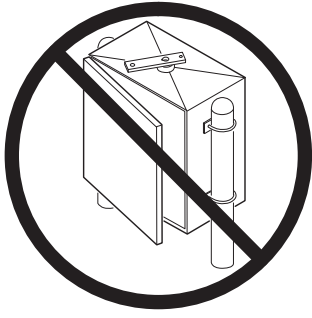



**WARNING**



**ONLY QUALIFIED TECHNICIANS SHOULD WORK ON LINEAR SWING GATE OPERATORS**

---



**WARNING**



**CONTROLS INTENDED FOR USER ACTIVATION MUST BE LOCATED AT LEAST SIX FEET (6') AWAY FROM ANY MOVING PART OF THE GATE AND WHERE THE USER IS PREVENTED FROM REACHING OVER, UNDER, AROUND OR THROUGH THE GATE TO OPERATE THE CONTROLS. OUTDOOR OR EASILY ACCESSIBLE CONTROLS SHALL HAVE A SECURITY FEATURE TO PREVENT UNAUTHORIZED USE.**

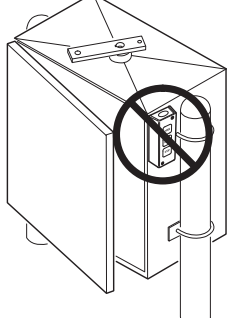

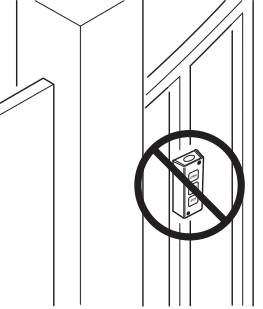

## Pre-installation Information

### Before You Begin...

Before unpacking, inspect the carton for exterior damage. If you find damage, advise the delivery carrier of a potential claim. Inspect your package carefully. You can check your accessory box parts with the enclosed packing slip for your convenience. Claims for shortages will be honored for only 30 days from the date of shipment.

Before installing the operator, read this manual completely to ensure all requirements for proper installation are present. Verify that the voltage to be used matches the voltage of the operator.

If you have any questions about the requirements for proper installation of this gate operator contact technical support at 800-421-1587.

### Always Check the Gate's Action

It's very important before installing the gate operator to make sure the gate's swing is free and level throughout the entire swing path. If the gate does not seem to operate properly, it may affect the operator performance or greatly shorten the life of the unit. The gate should also be designed so that airflow is ample to prevent wind resistance and drag.

### Gate Operator Classifications

All gate operators can be divided into one of four different classifications, depending on their design and usage. Install this gate operator only when the operator is appropriate for the construction and usage class as defined below:

- **Class I Residential Vehicular Gate Operator**  
A vehicular gate operator intended for use in a home or for one to four single family dwellings with a common garage or parking area associated with these dwellings.
- **Class II Commercial / General Access Vehicular Gate Operator**  
A vehicular gate operator intended for use in a commercial location or building such as a multi-family housing unit of five or more single family units, hotel, retail store or other building servicing the general public.
- **Class III Industrial / Limited Access Vehicular Gate Operator**  
A vehicular gate operator intended for use in an industrial location or building such as a factory or loading dock area or other location not intended to service the general public.
- **Class IV Restricted Access Vehicular Gate Operator**  
A vehicular gate operator intended for use in a guarded industrial location or building such as an airport security area or other restricted access locations not servicing the general public, in which unauthorized access is prevented via supervision by security personnel.

### Approved Obstruction Detection Devices

The following contact or non-contact obstruction detection devices have been approved for use with this swing gate operator as part of a UL325 compliant installation:

- **Contact Edges**  
Miller Edge Models MGO20, MGR20, MGS20, ME120
- **Photoeyes**  
MMTC Model IR-55 (165' range - P/N 2520-441)  
MMTC Model E3K (28' range - P/N 2520-031)

## Safety Information and Warnings

THE FOLLOWING FORMATS ARE USED FOR SAFETY NOTES IN THESE INSTRUCTIONS.



### Regulatory Warnings

Read the following before beginning to install this swing gate operator:

**IMPORTANT INSTALLATION SAFETY INSTRUCTIONS**

**WARNING**

**TO REDUCE THE RISK OF SEVERE INJURY OR DEATH TO PERSONS, REVIEW THESE INSTALLATION SAFETY STEPS BEFORE PROCEEDING**

1. READ AND FOLLOW ALL INSTALLATION INSTRUCTIONS.
2. Read the yellow "Safety Instructions" brochure enclosed with the packet of information. If any pages are missing or are unreadable, or you do not have the safety instructions, please call Linear at 1-800-421-1587 to request additional copies.
3. ALL ELECTRICAL CONNECTIONS TO THE POWER SUPPLY MUST BE MADE BY A LICENSED ELECTRICIAN AND MUST OBSERVE ALL NATIONAL AND LOCAL ELECTRICAL CODES.
4. A separate power-disconnect switch should be located near the operator so that primary power can be turned off when necessary.
5. Install the enclosed warning signs on both sides of the gate. A minimum of two (2) WARNING SIGNS shall be installed, one on each side of the gate where easily visible.
6. Never reach between, through or around the fence to operate the gate.
7. Never connect a button station within reach of the gate or on the side of the gate operator.
8. Do not adjust the operator controller's current sensing feature too high. It should be adjusted high enough to keep the gate from falsely triggering the sensing, but no higher than necessary for the gate to operate. **DO NOT DEFEAT THE PURPOSE OF THIS FUNCTION!**
9. You must install all required safety equipment.
10. UL325 Compliance requires the use of contact edges or photoelectric controls on all automatic or remotely-controlled gate operators.
11. The operator is intended for installation only on gates used for vehicles. Pedestrians must be supplied with a separate access opening. The pedestrian access opening shall be designed to promote pedestrian usage. Locate the gate such that persons will not come into contact with the vehicular gate during the entire path of travel of the vehicular gate.

## Wiring Specifications

Refer to the following steps for details on power and accessory wiring for the operator.



**WARNING**



**ALL AC ELECTRICAL CONNECTIONS TO THE POWER SOURCE AND THE OPERATOR MUST BE MADE BY A LICENSED ELECTRICIAN AND MUST OBSERVE ALL NATIONAL AND LOCAL ELECTRICAL CODES.**

### USE COPPER WIRE ONLY!

#### AC Power Wiring

1. Find the listing on this page corresponding to the model, voltage and horsepower rating of your operator.
2. The distance shown in the table is measured in feet from the operator to the power source. **DO NOT EXCEED THE MAXIMUM DISTANCE.** These calculations have been based on standard 115 V and 230 V supplies with a 10% drop allowable. If your supply is under the standard rating, the runs listed may be longer than what your application will handle, and you should not run wire too near the maximum distance for the gauge of wire you are using.
3. When large-gauge wire is used, a separate junction box (not supplied) may be needed for the operator power connection.
4. Wire length calculations are based on the National Electrical Code, Article 430 and have been carefully determined based on motor inrush, brake solenoids, and operator requirements.
5. Connect power in accordance with local codes. **The green ground wire must be properly connected.**
6. Wire insulation must be suitable to the application.
7. Electrical outlets are supplied in all 115 VAC models for convenience with occasional use or low power consumption devices only. If you choose to run dedicated equipment from these devices, it will decrease the distance for maximum length and the charts will no longer be accurate.

#### DC Control and Accessory Wiring

1. All control devices are now 24 VDC, which can be run up to 2000 feet with 14 AWG wire.
2. Control wiring must be run in a separate conduit from power wiring. Running them together may cause interference and faulty signals in some accessories.
3. A three-wire shielded conductor cable is required to connect two operators together for dual operation. You must use Belden 8760 Twisted Pair Shielded Cable (or equivalent) only – P/N 2500-1982, per foot). See Page 21 for details of this connection. **Note: The shield wire should be connected in both the operators.**

MODEL VS-GSWG SINGLE PHASE POWER WIRING			
VOLTS & HP	MAXIMUM DISTANCE (FEET)		WIRE GAUGE
	SINGLE	DUAL	
115 VOLTS 1/2-HP	222	111	12
	354	177	10
	566	283	8
	900	450	6
	1430	715	4
115 VOLTS 3/4-HP	178	89	12
	282	141	10
	450	255	8
	716	358	6
	1140	570	4
115 VOLTS 1-HP	160	80	12
	254	127	10
	406	203	8
	646	323	6
	1026	513	4
208 VOLTS 1/2-HP	760	380	12
	1200	600	10
	1924	962	8
	3060	1830	6
	4864	2432	4
208 VOLTS 3/4-HP	604	302	12
	958	478	10
	1526	763	8
	2424	1212	6
	3856	1928	4
208 VOLTS 1-HP	544	272	12
	864	432	10
	1374	686	8
	2184	1092	6
	3476	1738	4
230 VOLTS 1/2-HP	894	447	12
	1422	711	10
	2264	1132	8
	3600	1800	6
	5724	2862	4
230 VOLTS 3/4-HP	710	355	12
	1128	564	10
	1796	898	8
	2852	1426	6
	4538	2269	4
230 VOLTS 1-HP	640	320	12
	1016	508	10
	1616	808	8
	2570	1285	6
	4090	2045	4

MODEL VS-GSWG THREE PHASE POWER WIRING			
VOLTS & HP	MAXIMUM DISTANCE (FEET)		WIRE GAUGE
	SINGLE	DUAL	
208 VOLTS 1/2-HP	1142	571	12
	1816	908	10
	2890	1445	8
208 VOLTS 3/4-HP	920	460	12
	1464	732	10
	2330	1165	8
208 VOLTS 1-HP	714	357	12
	1136	568	10
	1804	902	8
230 VOLTS 1/2-HP	1344	672	12
	2137	1069	10
	3400	1700	8
230 VOLTS 3/4-HP	1084	542	12
	1723	862	10
	2741	1371	8
230 VOLTS 1-HP	840	420	12
	1336	668	10
	2124	1062	8
460 VOLTS 1/2-HP	3841	1921	12
	6106	3053	10
	9712	4856	8
460 VOLTS 3/4-HP	3279	1640	12
	5212	2606	10
	8291	4146	8
460 VOLTS 1-HP	2689	1345	12
	4274	2437	10
	6798	3399	8

## Mounting Pad Installation

The gate operator mounts bolted to posts secured in concrete footings. The posts support the operator and prevent it from moving during operation.

### Gate Preparation

Before installing the gate operator, make sure the gate's swing is free and level throughout the entire swing path. If the gate does not seem to operate properly, it may affect the operator performance or greatly shorten the life of the unit. The gate should be designed so that airflow is ample to prevent wind resistance and drag.

### Mounting Specifications

Use two 3 - 3-1/2" OD galvanized posts and secure with concrete footings as shown, length to be determined by local codes, frost line depth and soil conditions.

Attach the operator with the U-bolts, side plates and hardware provided. Four 3/16" side plates go on the outside top and bottom, two 3/16" side plates go on the inside top, and two 1/2" side plates go on the inside bottom (see the illustration at right). The operator should be positioned at a level to allow the arm to be installed at mid-height on the gate. "H" dimension can vary depending on gate construction. Make sure the posts do not protrude above the operator cabinet.

✓ **NOTE:** If non-standard mounting is necessary, consult the factory.

**⚠ WARNING ⚠**  
**The operator is intended for installation only on gates used for vehicles. Pedestrians must be supplied with a separate access opening. The pedestrian access opening shall be designed to promote pedestrian usage. Locate the gate such that persons will not come into contact with the vehicular gate during the entire path of travel of the vehicular gate.**

**⚠ WARNING ⚠**  
**The gate must be installed in a location so that enough clearance is supplied between the gate and adjacent structures when opening and closing to reduce the risk of entrapment. Swing gates shall not open into public areas.**

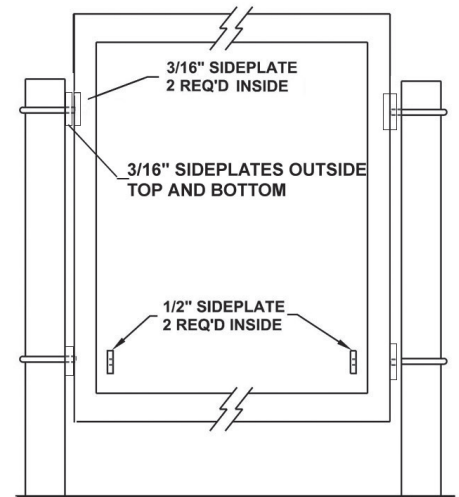

Figure 1. Side Plate Installation

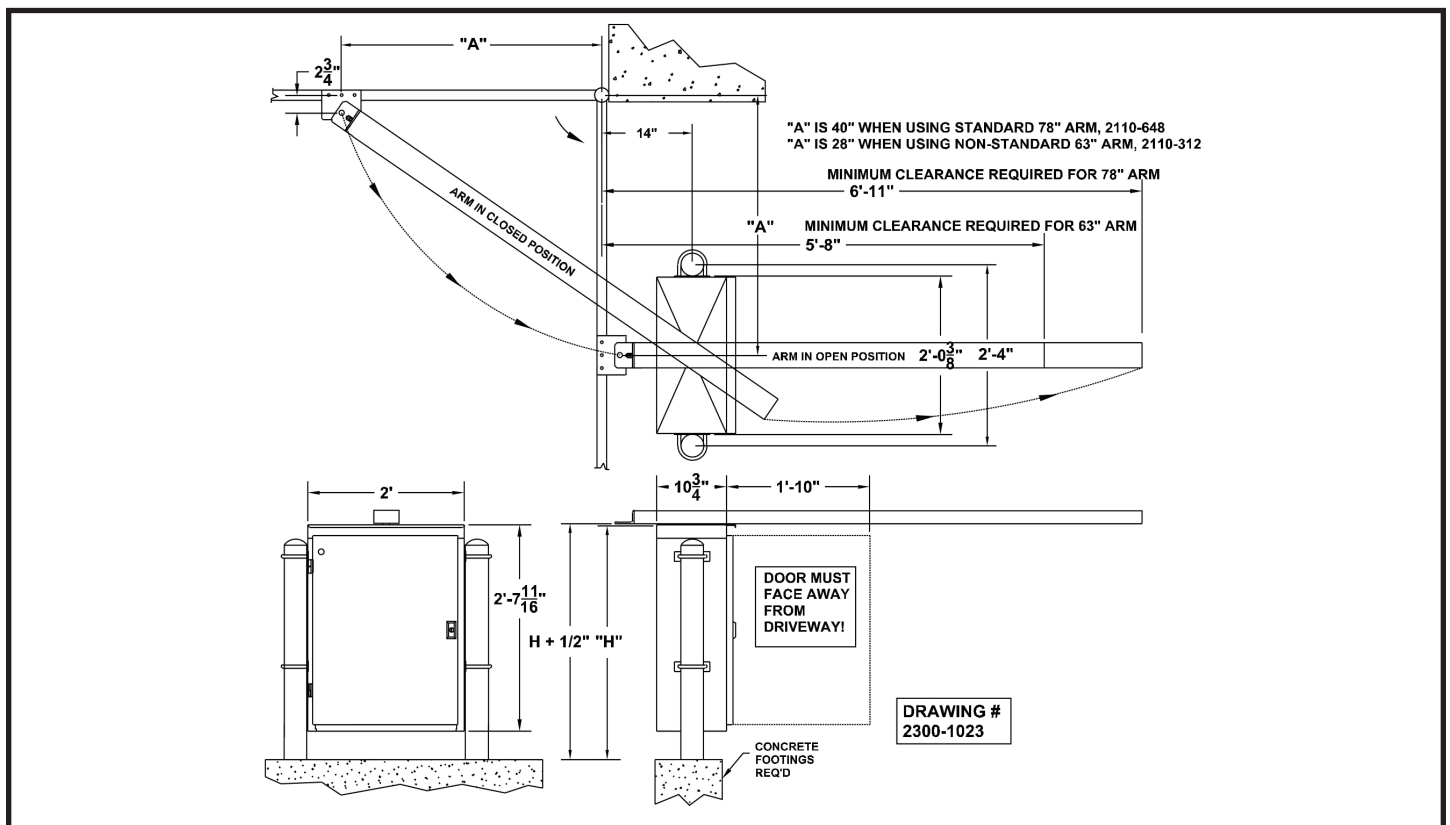

Figure 2. Mounting Pad Specifications

## Operator Preparation

### Vent Plug Installation

In order to keep gear oil from spilling out during shipping, gear reducers used in gate operators have either a solid plug, or a sealed vent plug, installed at the factory.

For operators with a solid plug, replace the solid plug with the vent plug provided (see Figure 3).

With the vent plug installed, remove the vent plug's breather pin to allow the gear box to vent (see Figure 3).

### Gate Arm Installation

The gate arm connects the operator to the gate. The arm supplied can be used in left-hand or right-hand installations.

#### Gate Arm Assembly

Refer to Figure 4.

1. Remove the arm assembly cover.
2. Place the center hole in the rail guide over the 1" drive shaft.
3. Place the drive sprocket on drive shaft. Be sure the keyway is in place and set screws are secured.
4. Connect the gate bracket to the gate. Manually open the gate to approximately half-open position.
5. String the arm assembly chain as shown in Figure 4.
- ✓ **NOTE:** Observe the way the chain threads around the sprockets for left-hand or right-hand installations. Refer to Figure 4.
6. Adjust for taut chain tension but do not overtighten.
7. Replace the arm assembly cover.

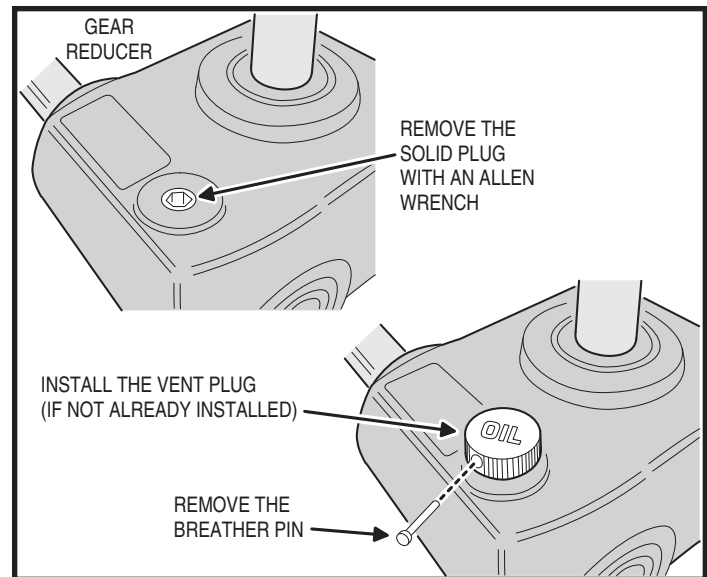

Figure 3. Vent Plug Installation

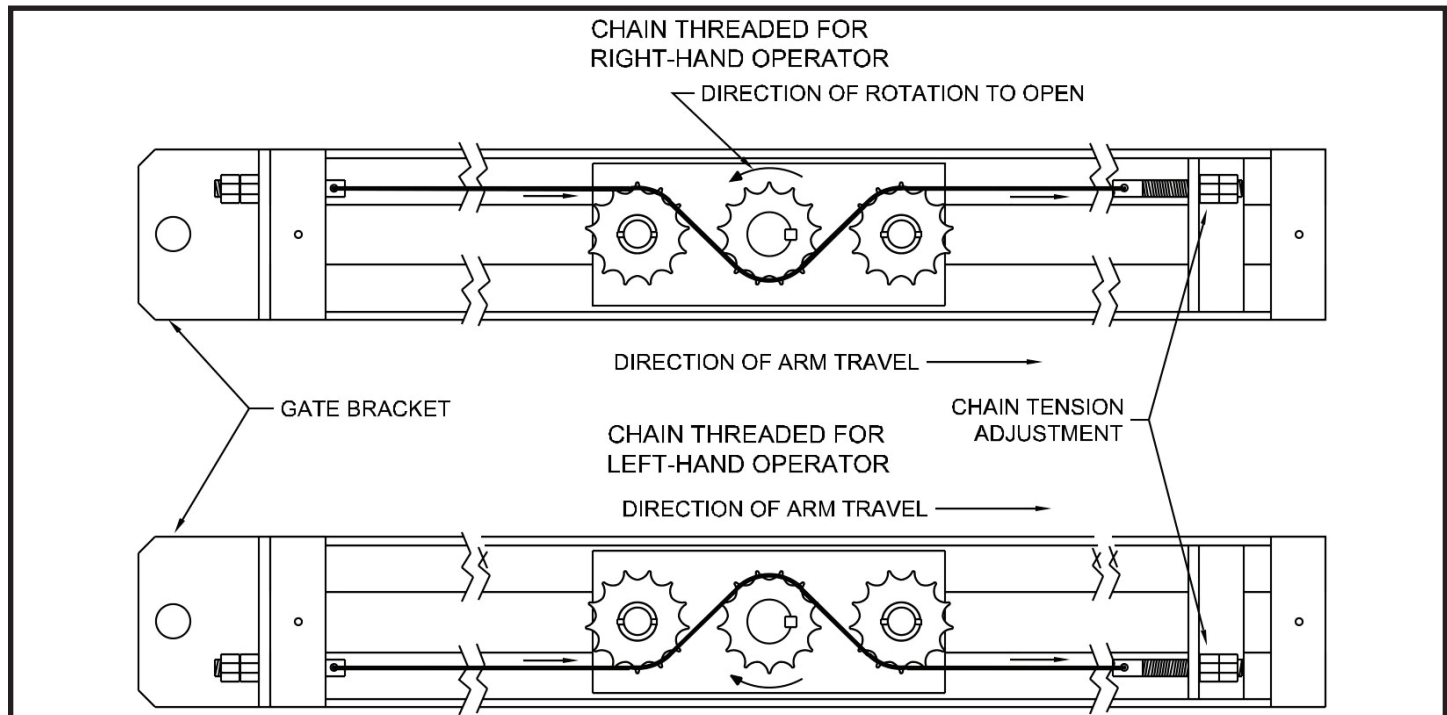

Figure 4. Gate Arm Assembly

## Operator Setup

### Controller Access

The Controller is protected by a plastic dust cover. To remove the dust cover, loosen the cover's wing-screw and lift the cover off (see Figure 5).

**⚡ WARNING ⚡**

**ALL AC ELECTRICAL CONNECTIONS TO THE POWER SOURCE AND THE OPERATOR MUST BE MADE BY A LICENSED ELECTRICIAN AND MUST OBSERVE ALL NATIONAL AND LOCAL ELECTRICAL CODES**

### AC Power Connection

All Linear gate operators are supplied with a power disconnect switch to turn on and off the power available to the operator. Following wiring specifications on Page 2, incoming power should be brought into the operator and connected to the labeled pigtails from the disconnect box. A wiring connections print can also be found on the label inside the cover of the operator.

Proper thermal protection is supplied with the operator. The motor contains a thermal overload protector to guard from overheating the motor due to overload or high-frequency operation. This overload protector will reset automatically after the motor cools down.

### Earth Ground

Install a ground rod and connect it to the operator's frame in every gate operator installation. A good earth ground is necessary to allow the Controller's built-in surge and lightning protection circuitry to work effectively. The physical bolting of the operator to the mounting posts **is not** sufficient for a good earth ground.

✓ **NOTE:** Do not splice the ground wire. Use a single piece of solid copper 12 AWG wire between the ground rod and the operator.

1. Install an 8-foot long copper ground rod next to the operator mounting pad within three feet of the operator.
2. Use a clamp to connect a solid copper 12 AWG ground wire to the ground rod.
3. Route the ground wire to the operator.
4. Connect the ground wire to the operator's frame.

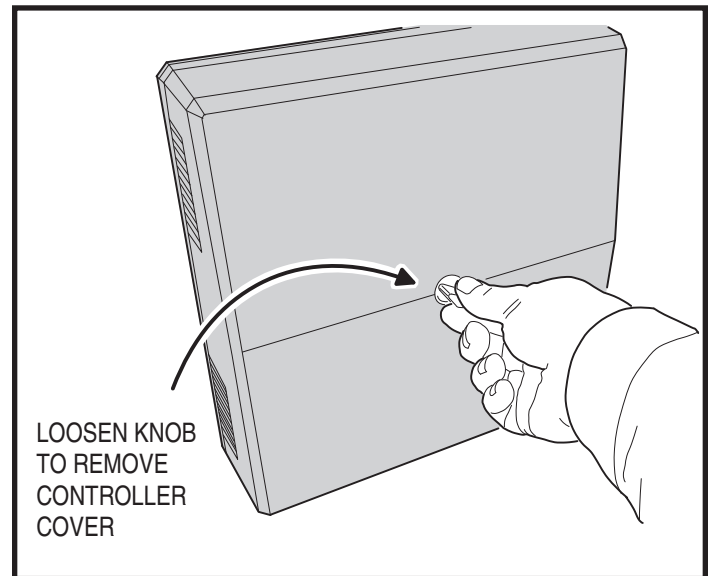

Figure 5. Controller Access

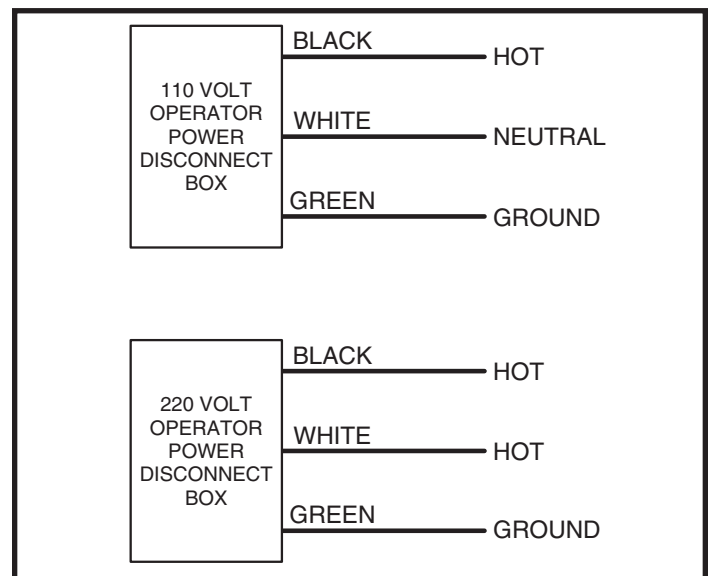

Figure 6. Power Disconnect Box Wiring

## Operator Setup (cont.)

### Open and Close Limit Adjustment

The limit nuts are not preset at the factory and must be adjusted for the gate in each installation. The limit switches are activated by two threaded nylon rotary limit nuts which are attached to a threaded limit shaft driven by a chain and sprockets from the main drive shaft. **REMOVE THE CARDBOARD FILLER BEFORE ADJUSTING THE LIMIT NUTS.**

The Controller is factory setup for right-hand installations. The **OPEN** limit switches are the ones closer to the bottom of the operator. In left-hand installations, the **CLOSE** limit switches are the ones closer to the bottom of the operator (see Figures 7 & 8).

### ⚠ CAUTION ⚠

**If the operator is installed in a left-hand installation. Set the Controller to left-hand operation BEFORE running the operator for the fine setting of the limit cams. Failure to do so will result in over-shooting the limit switches, and may cause damage to the operator and/or gate. Refer to programming on Page 12.**

### Limit Nuts Rough Adjustment

Before running the operator, set the limit nuts as follows:

1. With the gate connected to the gate operator in a mid-travel position, turn the power disconnect switch **OFF**.
2. To adjust the limit nuts, press down on the detent plate and rotate the limit nut along the threaded shaft (see Figure 9).
3. Adjust the **OPEN** limit nut until it is about 1/2" from activating the LSO-2 **OPEN** limit switch.
4. Adjust the **CLOSE** limit nut until it is about 1/2" from activating the LSC-2 **CLOSE** limit switch.

### Limit Nuts Fine Adjustment

After finishing the rough limit nut adjustments, run the operator to set the fine limit adjustment.

1. Turn the power disconnect switch **ON**.
2. Stand clear of any moving parts and press the **OPEN** button.
3. After the gate opens, press the **CLOSE** button.
4. Observe the gate in both directions as it runs through each complete cycle. Adjust the open or close limit nuts again if necessary. Fine levels of adjustment can be made by adjusting a few teeth on the nut at a time. If the gate stops during travel, you may need to adjust the Open or Close Current Setting or the Maximum Run Timer (see Pages 13-14).

### Setting Speeds using LSO-2 & LSC-2

Limit switches LSO-2 and LSC-2 control when the operator accelerates to maximum speed and decelerates to minimum speed. It is recommended that LSO-2 and LSC-2 are adjusted first so the gate slows to near stop before hitting LSO-1 or LSC-1 as these will apply the brake upon activation.

Adjust LSO-2 and LSC-2 by slightly loosening the two screws which hold them in place and sliding toward or away from the center of the limit box. Care must be taken not to adjust too close to the center as the limit nut may travel past the switch and start accelerating at the end of the cycle.

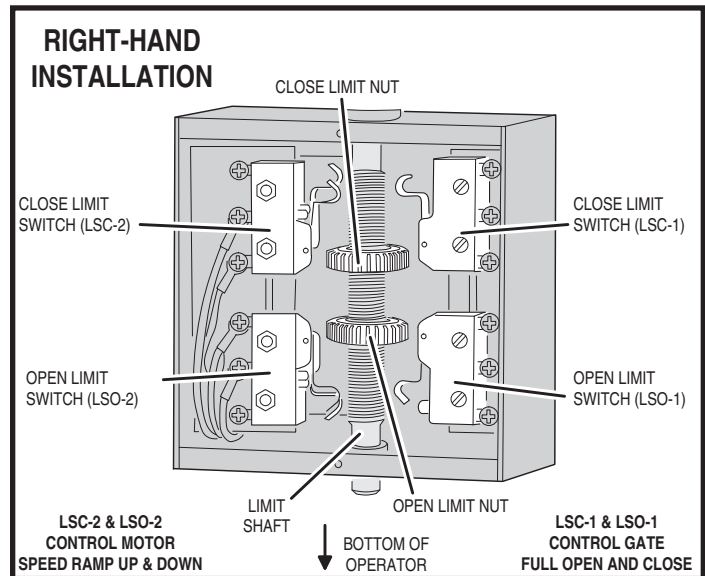

Figure 7. Limit Box Assembly (Right-hand Installation)

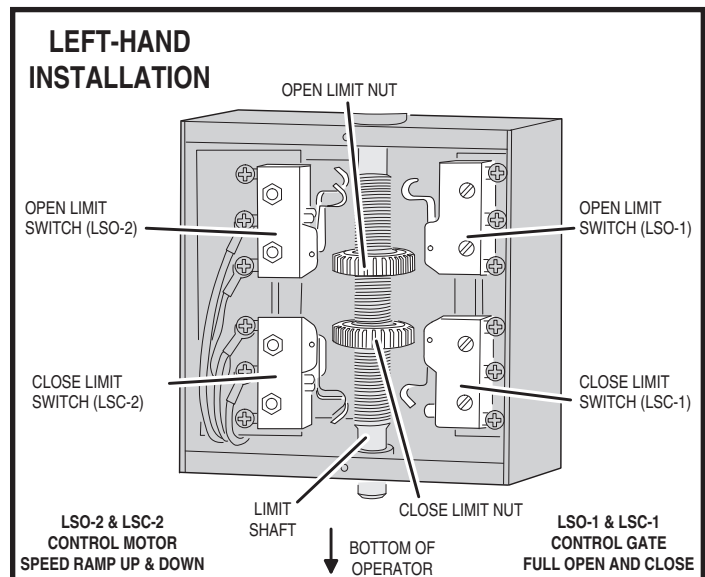

Figure 8. Limit Box Assembly (Left-hand Installation)

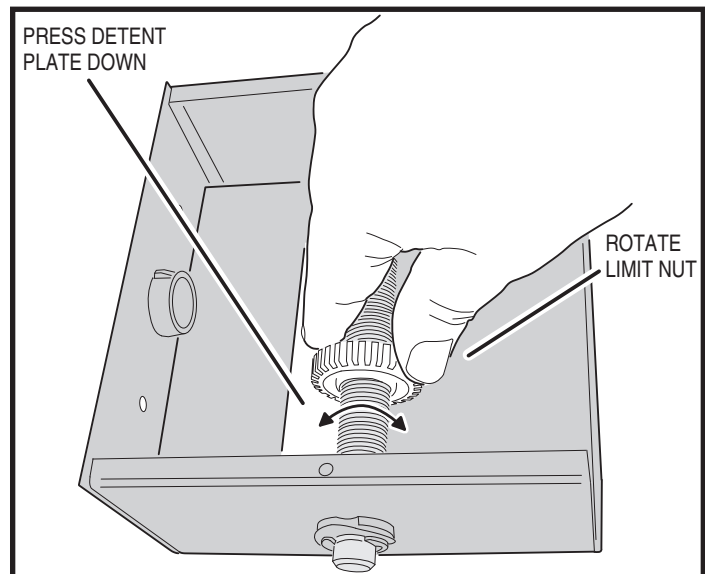

Figure 9. Setting the Limits



## Torque Limiter Adjustment

Before adjusting the torque limiter, make sure the gate is in good working condition. With the gate disconnected from the gate arm, one person should be able to move the gate by hand. Be certain the gate moves freely and without binding throughout its travel.

Torque limiters are set light at the factory. They must be adjusted during installation, preferably after limit cams have been manually set. With the gate arm and gate attached, adjust the torque limiter tight enough to keep it from slipping during normal operation. The inherent entrapment protection (current sensing) feature must activate prior to any slipping of the torque limiter.

✓ **NOTE:** The open and close current sensing may need to be adjusted before performing the following two steps. See Page 13.

### To adjust the torque limiter in a Model VS-GSWG:

1. Loosen the set screw on the adjustment nut.
2. Cycle the gate open and closed while observing the torque limiter action. **TURN THE OPERATOR POWER DISCONNECT SWITCH OFF BEFORE MAKING ANY ADJUSTMENTS.**

To *increase the torque*, turn the adjustment nut clockwise one flat, or 1/6 turn, at a time until desired output is obtained.

To *reduce the torque*, turn the adjustment nut counterclockwise one flat, or 1/6 turn, at a time until desired output is obtained.

3. When finished, tighten the set screw to lock the adjustment nut in place.

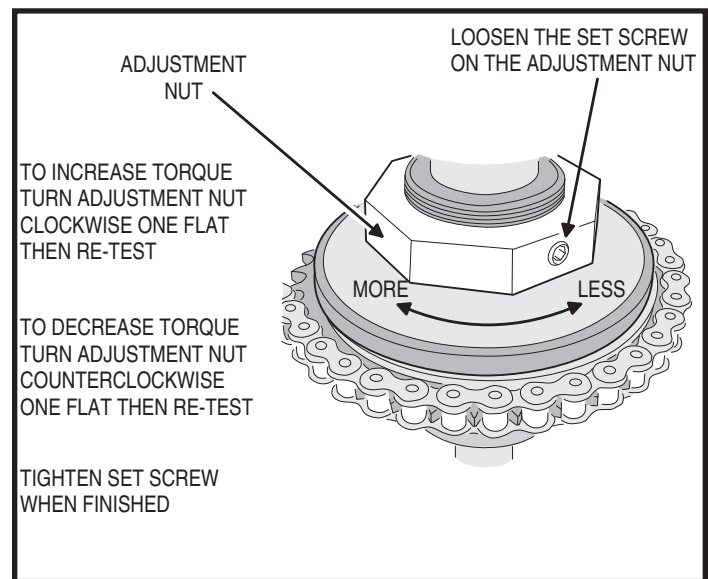

Figure 10. Model SWG Torque Limiter

# Controller Features

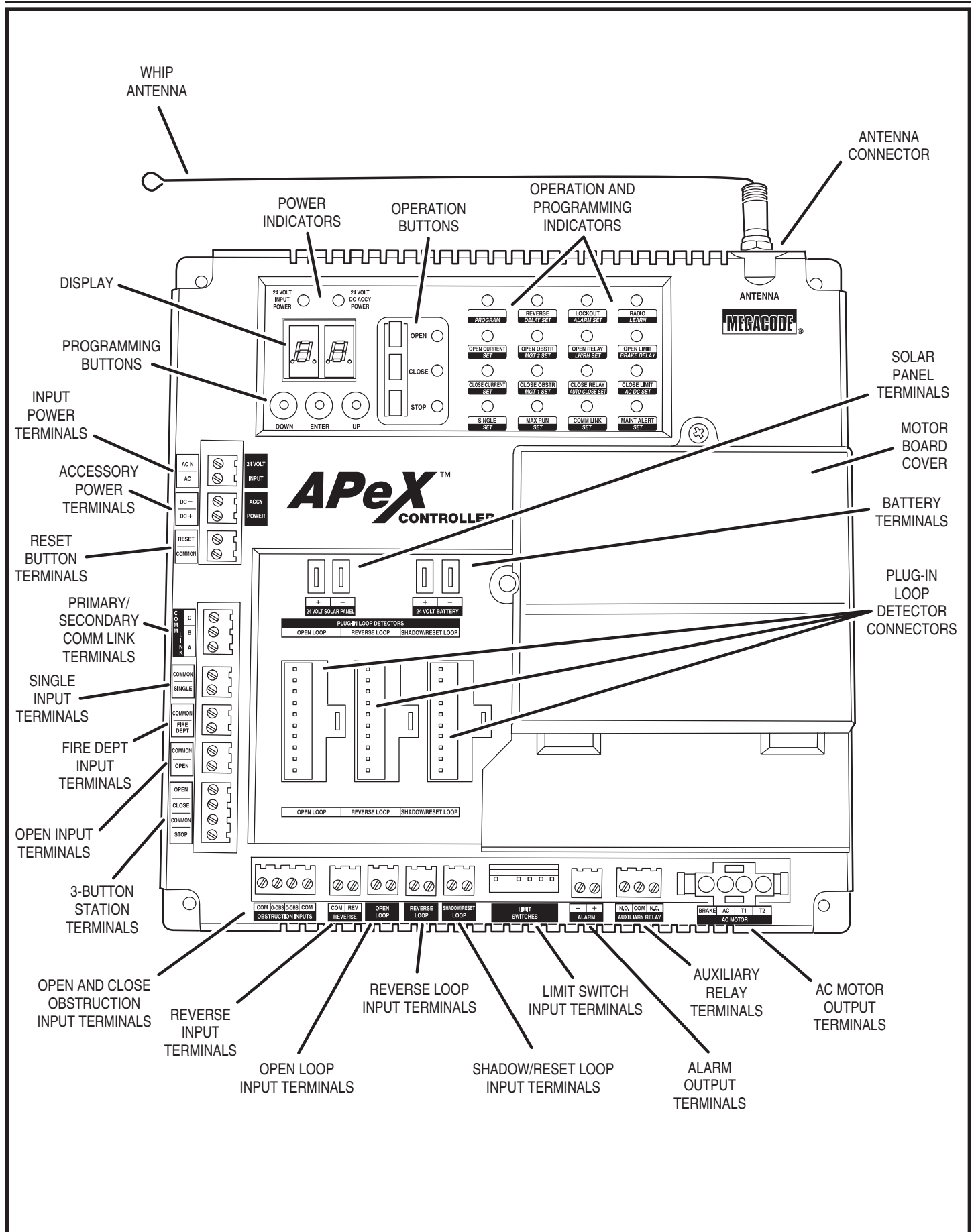





























Figure 11. Controller Features

# Indicator Descriptions

INDICATOR DEFINITION		INDICATION WHEN LIT DURING NORMAL OPERATION	INDICATION WHEN LIT DURING PROGRAMMING
OPERATION	PROGRAMMING		
24 VOLT INPUT POWER		LOW VOLTAGE AC POWER IS PRESENT	
24 VOLT DC ACCY POWER		LOW VOLTAGE DC POWER IS PRESENT	
OPEN		OPEN SIGNAL PRESENT FROM THE INTERNAL RECEIVER OR AN EXTERNAL DEVICE CONNECTED TO THE OPEN INPUT TERMINAL	
CLOSE		CLOSE SIGNAL IS PRESENT FROM A DEVICE CONNECTED TO THE CLOSE INPUT TERMINAL	
STOP		STOP INPUT TERMINAL IS OPEN AND NOT CONNECTED TO COMMON	
PROGRAM			CONTROLLER IS IN PROGRAMMING MODE
REVERSE	DELAY SET	SIGNAL FROM REVERSING DEVICE IS PRESENT	SET REVERSE DELAY TIME
LOCKOUT	ALARM SET	CONTROLS AND OPERATOR ARE LOCKED OUT BECAUSE OF EXISTING TROUBLE CONDITION	SET RUN ALARM AND PRE-START ALARM
RADIO	LEARN	BUILT-IN RECEIVER IS DETECTING A RADIO SIGNAL FROM A REMOTE CONTROL	TRANSMITTERS CAN BE ENTERED INTO MEMORY (UP TO 40 TRANSMITTERS)
OPEN CURRENT	SET	MOTOR CURRENT HAS EXCEEDED THE OPEN CURRENT SETTING WHILE OPENING	SET MAXIMUM OPEN CURRENT
OPEN OBSTR	MGT 2 SET	OPEN OBSTRUCTION TERMINAL CONNECTED TO COMMON BY BEAM OR SAFETY EDGE, OR SIGNAL FROM MGT OBSTACLE TRANSMITTER	SET MGT #2 FUNCTION
OPEN RELAY	LH/RH SET	OPEN RELAY IS ACTIVATED	SET LEFT-HAND RIGHT-HAND OPERATION
OPEN LIMIT	BRAKE DELAY	OPEN LIMIT SWITCH IS ACTIVATED	
CLOSE CURRENT	SET	MOTOR CURRENT HAS EXCEEDED THE CLOSE CURRENT SETTING WHILE CLOSING	SET MAXIMUM CLOSE CURRENT
CLOSE OBSTR	MGT 1 SET	CLOSE OBSTRUCTION TERMINAL CONNECTED TO COMMON BY BEAM OR SAFETY EDGE, OR SIGNAL FROM MGT OBSTACLE TRANSMITTER	SET MGT #1 FUNCTION
CLOSE RELAY	AUTO CLOSE SET	CLOSE RELAY IS ACTIVATED	SET AUTO-CLOSE TIME
CLOSE LIMIT	AC DC SET	CLOSE LIMIT SWITCH IS ACTIVATED	SET MOTOR TYPE
SINGLE	SET	SINGLE TERMINAL CONNECTED TO COMMON BY AN EXTERNAL PUSHBUTTON OR RADIO	SET SINGLE BUTTON INPUT FUNCTION
MAX RUN	SET	MAXIMUM RUN TIMER HAS BEEN EXCEEDED	SET MAXIMUM RUN TIME
COMM LINK	SET	DUAL OPERATOR CONNECTION DETECTED, BLINKS IF CONNECTION HAS FAILED	
MAINT ALERT	SET	MAINTENANCE IS REQUIRED ON OPERATOR	SET MAINTENANCE ALERT CYCLE COUNT

## APEX FUNCTION DISPLAY INDICATIONS

 "RL" LEFT OR RIGHT HAND OPERATION	 "RT" MAXIMUM RUN TIMER	 "CP" CONSTANT PRESSURE MODE	 "TL" LEARN TRANSMITTERS
 "PM" SINGLE OR DUAL GATE	 "SB" SINGLE BUTTON INPUT SETUP	 "SP" SHADOW LOOP OPEN INHIBIT	 "TD" DELETE TRANSMITTERS
 "AC" AUTO CLOSE TIMER	 "SM" STAGGER MODE	 "CT" RESET CYCLE COUNT	 "ML" LEARN MGT TRANSMITTERS
 "RP" RUN ALARM PRE-START ALARM	 "ST" STAGGER TIME	 "MA" MAINTENANCE ALERT TRIGGER	 "MD" ERASE MGT TRANSMITTERS
 "OC" MAXIMUM OPEN CURRENT	 "AR" AUXILIARY RELAY MODE	 "MT" MID-TRAVEL STOP POSITION	 "MO" MOTOR TYPE SELECTION
 "CC" MAXIMUM CLOSE CURRENT	 "RD" REVERSE DELAY TIME	 "AT" ANTI-TAILGATE ENABLE	 "CL" RESET TO FACTORY DEFAULTS
 "AD" ADVANCED PROGRAMMING	 "BD" BRAKE DELAY TIME	 "RA" RADIO ENABLE	

## Terminal Descriptions

TERMINAL	GROUP	FUNCTION
AC N AC	24 VOLT INPUT	FACTORY CONNECTED TO 24 VAC FROM TRANSFORMER OR 24 VDC FROM CONTINUOUS DUTY DC SUPPLY.
DC - DC +	ACCESSORY POWER	PROVIDES 24 VOLT DC POWER FOR ACCESSORIES. (.5A MAX)
RESET COMMON	RESET BUTTON	FACTORY CONNECTED TO THE CONTROLLER'S RESET BUTTON.
C B A	COMM LINK	FOR 3-WIRE NETWORK CONNECTION TO SECOND OPERATOR IN DUAL GATE INSTALLATIONS.
COMMON SINGLE	SINGLE BUTTON INPUT	CONNECT TO NORMALLY OPEN SWITCH FOR SINGLE BUTTON OPERATION. ALTERNATES BETWEEN OPEN-CLOSE OR OPEN-STOP-CLOSE DEPENDING ON PROGRAMMING.
COMMON FIRE DEPT	FIRE BOX INPUT	CONNECT TO NORMALLY OPEN SWITCH IN FIRE BOX FOR FIRE DEPARTMENT ACCESS.
COMMON OPEN	OPEN INPUT	CONNECT TO NORMALLY OPEN DEVICES (KEYPAD, CARD READER, KEYSWITCH, TELEPHONE ENTRY SYSTEM) TO OPEN THE GATE. A CONSTANT OPEN INPUT WILL OVERRIDE THE MID-TRAVEL STOP AND HALT THE AUTO CLOSE TIMER UNTIL RELEASED.
OPEN CLOSE COMMON STOP	3-BUTTON STATION INPUT	CONNECT TO 3-BUTTON STATION FOR OPEN-CLOSE-STOP CONTROL. A CONSTANT OPEN INPUT WILL OVERRIDE THE MID-TRAVEL STOP AND HALT THE AUTO CLOSE TIMER UNTIL RELEASED.
COM O-OBS	OPEN OBSTRUCTION INPUT	CONNECT TO NORMALLY OPEN DEVICES (GATE EDGE, PHOTO BEAM) TO DETECT AN OBSTRUCTION DURING OPENING. WHILE GATE IS MOVING, ANY OPEN OBSTRUCTION SIGNAL WILL CAUSE THE GATE TO STOP, REVERSE A SHORT DISTANCE, AND THEN STOP AGAIN. AT THIS TIME THE AUTO CLOSE TIMER IS DISABLED, AND A RENEWED INPUT WILL BE REQUIRED TO START THE GATE AGAIN. SHOULD THE GATE BE RESTARTED AND THE OBSTACLE SIGNAL OCCUR AGAIN PRIOR TO REACHING A LIMIT, THE GATE WILL STOP AGAIN, LOCKOUT, AND SOUND THE CONTINUOUS TONE ALARM.
C-OBS COM	CLOSE OBSTRUCTION INPUT	CONNECT TO NORMALLY OPEN DEVICES (GATE EDGE, PHOTO BEAM) TO DETECT AN OBSTRUCTION DURING CLOSING. WHILE GATE IS MOVING, ANY CLOSE OBSTRUCTION SIGNAL WILL CAUSE THE GATE TO STOP, THEN REVERSE AND TRAVEL TO THE FULL OPEN POSITION. SHOULD A OPEN OBSTRUCTION INPUT OR AN OPEN DIRECTION INHERENT ENTRAPMENT CONDITION OCCUR PRIOR TO THE GATE REACHING THE OPEN LIMIT, THE OPERATOR WILL LOCKOUT AND SOUND THE CONTINUOUS TONE ALARM. IF THE AUTO CLOSE TIMER IS SET, WHEN THE CLOSE OBSTRUCTION INPUT IS CLEARED, THE GATE WILL CLOSE WHEN THE AUTO CLOSE TIMER EXPIRES.
COM REV	REVERSE	CONNECT TO NORMALLY OPEN DEVICES TO CAUSE A REVERSAL WHEN THE GATE IS TRAVELING CLOSED. THE GATE WILL REVERSE TO THE FULL OPEN POSITION.
OPEN LOOP OPEN LOOP	OPEN LOOP	CONNECT TO OPEN LOOP/FREE EXIT LOOP. THE GATE WILL OPEN WHEN THE LOOP IS TRIGGERED, AND REMAIN OPEN AS LONG AS THE LOOP IS TRIGGERED. REQUIRES LOOP DETECTOR.
REVERSE LOOP REVERSE LOOP	REVERSE LOOP	CONNECT TO REVERSE LOOP. TRIGGERING THE LOOP WILL CAUSE A REVERSAL WHEN THE GATE IS TRAVELING CLOSED. THE GATE WILL REVERSE TO THE FULL OPEN POSITION. REQUIRES LOOP DETECTOR.
SHADOW/RESET LOOP SHADOW/RESET LOOP	SHADOW/RESET LOOP	CONNECT TO SHADOW/RESET LOOP TO KEEP THE GATE IN ITS FULLY OPEN POSITION AS LONG AS THE SIGNAL IS PRESENT. USED TO KEEP GATE OPEN WHILE VEHICLE IS PASSING THROUGH. REQUIRES LOOP DETECTOR.
- +	ALARM	FACTORY CONNECTED TO THE ALARM BEEPER.
N.O. COM N.C.	AUX RELAY	FOR CONNECTION TO AUXILIARY DEVICES (MAGNETIC LOCK, SOLENOID LOCK, STROBE LIGHT) FOR ACTIVATION (OR DEACTIVATION) DURING GATE OPERATION.
+ -	24 VOLT SOLAR PANEL	NOT USED WITH THIS MODEL OPERATOR.
+ -	24 VOLT BATTERY	NOT USED WITH THIS MODEL OPERATOR.

# Operator Accessory Connections

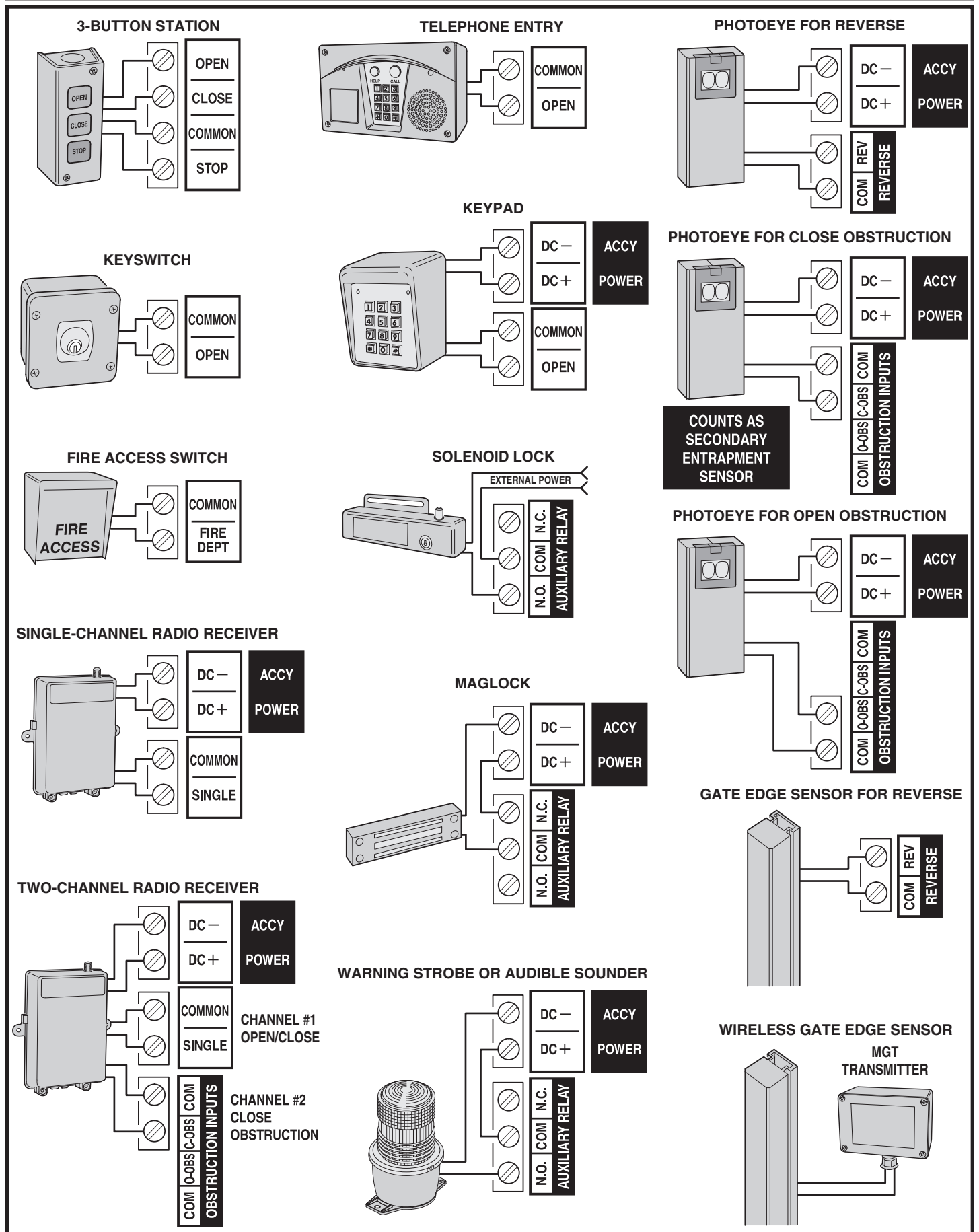

Figure 12. Operator Accessory Connections

# Basic Controller Programming

## Programming Overview

The Controller can be programmed with various options for the operator. The programming fields are defined as “functions” that have “options”. To make setup easier for the installer, the Controller’s programming is divided into two groups: basic and advanced. The basic programming group contains the functions commonly used in most swing gate installations. The advanced programming group contains functions less commonly used (i.e. dual gate stagger delay, maximum run timer, etc.).

## Entering Programming Mode

Enter programming mode by pressing the **UP** and **DOWN** buttons together for one second. While in programming mode the **PROGRAM** indicator will light.

## Exiting Programming Mode

Exit programming mode at any time by pressing the **UP** and **DOWN** buttons together. The Controller will automatically exit programming mode after three minutes of inactivity.

## Programming Keystrokes

### (Typical Programming Method)

While in programming mode, press the **UP** or **DOWN** buttons to scroll through the programming functions. When the desired function is displayed press the **ENTER** button to display the currently set option for the function. **When an option is displayed, the decimal points are lit.**

To change the option, press and hold the **ENTER** button for 1 second. To indicate that an option is ready to be changed, the display will flash. While the display is flashing, press the **UP** or **DOWN** button to display the other options available for that function.

When the desired option is displayed, press the **ENTER** button to store it into memory. To select another function, press **ENTER, UP,** or **DOWN.**

## Left or Right Hand Operation

The factory default is for right hand operation (operator on right side of the driveway when viewed from the inside of the gate). For left hand installations, program the Controller for left hand operation.

## Dual Gate Enable

The factory default is for single gate operation. For dual gate operation, wire the two gate controllers together through the **COMM LINK** terminals (see Page 21) and enable dual gate operation with this programming step.

✓ **NOTE:** The Mid-travel Stop feature is disabled when dual gate operation is enabled for paired units.

## Auto Close Timer

The factory default turns off the Auto Close Timer. The timer can be set from 1 to 59 seconds and from 1 to 9 minutes. When the Auto Close Timer is set, after opening, the gate will wait for the length of the Auto Close Timer then close automatically.

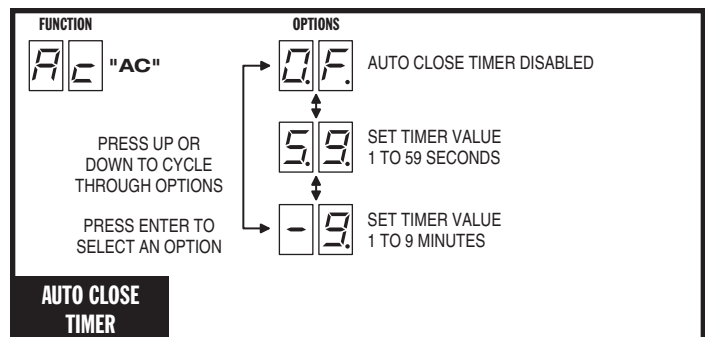
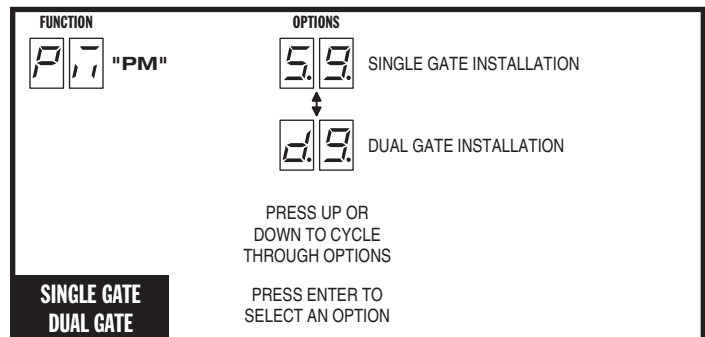
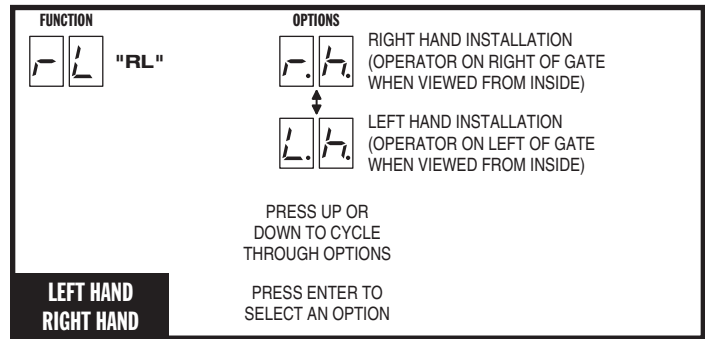
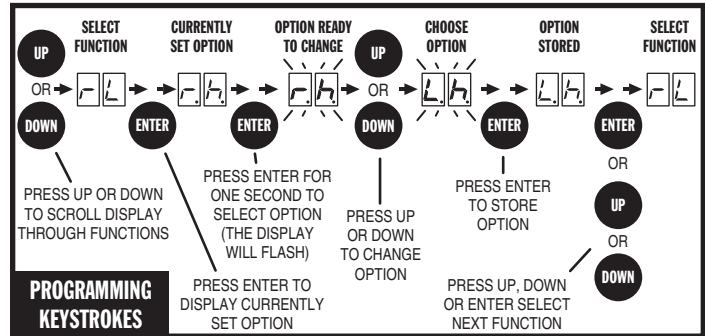
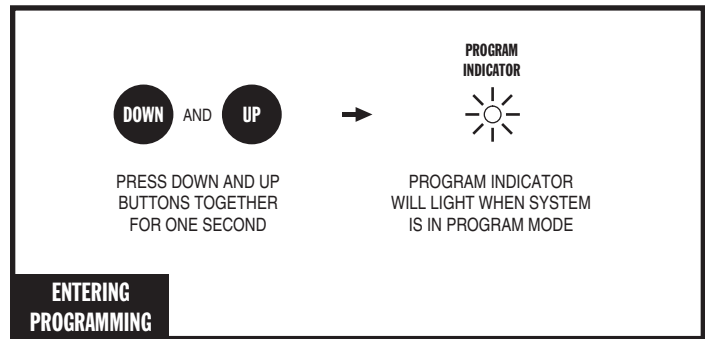

## Basic Controller Programming (Cont.)

### Run Alarm and Pre-start Alarm

The factory default is Run Alarm on and a 3-second Pre-start Alarm. The operator's beeper will sound 3 seconds before the operator starts. The options are:

- Run Alarm Off and Pre-start Alarm Off
- Run Alarm On and Pre-start Alarm Off
- Run Alarm On and Pre-start Alarm On for 1-9 Seconds

### Maximum Open Direction Current Setting

To detect obstacles or mechanical problems with the gate, the operator monitors its motor current. If the open current load exceeds the programmed maximum load range number, the operator will stop, reverse a short distance, then stop again. The Auto Close Timer will be disabled, and another open request will be required to start the operator again. If after restart, the overload or an open obstacle happens again before the open limit is reached, the operator will lockout and sound the alarm.

To measure the motor load used during opening, **while this function is being displayed**, push and hold the **OPEN** button to fully open the gate. During movement, the motor current will be displayed as a load number from 0 to 99. This number is useful for troubleshooting but not for setting the motor current. At the end of travel, a different number will flash. This number indicates the range above and below the average motor current during the run. Using the + and - buttons, set the programmed range number so that a minimal force (50-75 lbs.) will activate a reversal should an obstruction occur, but high enough to keep the gate moving under normal conditions without interruption.

### Maximum Close Direction Current Setting

To detect obstacles or mechanical problems with the gate, the operator monitors its motor current. If the close current load exceeds the programmed maximum load range number, the operator will stop, reverse, and travel to the full open position. Should a open obstruction input or an open direction inherent entrapment condition occur prior to the gate reaching the open limit, the operator will lockout and sound the continuous tone alarm. Another close request will be required to start the operator again. If after restart, the overload or a close obstacle happens again before the close limit is reached, the operator will lockout and sound the alarm. If the auto close timer is set, when the close obstruction input is cleared, the gate will close when the auto close timer expires.

To measure the motor load used during closing, **while this function is being displayed**, push and hold the **CLOSE** button to close the gate. During movement, the motor current will be displayed as a load number from 0 to 99. This number is useful for troubleshooting but not used for setting the motor current. At the end of travel, a different number will flash. This number indicates the range above and below the average motor current during the run. Using the + and - buttons, set the programmed range number so that a minimal force (50-75 lbs.) will activate a reversal should an obstruction occur, but high enough to keep the gate moving under normal conditions without interruption.

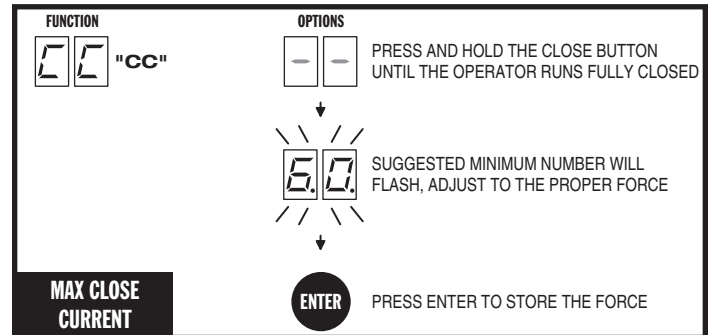
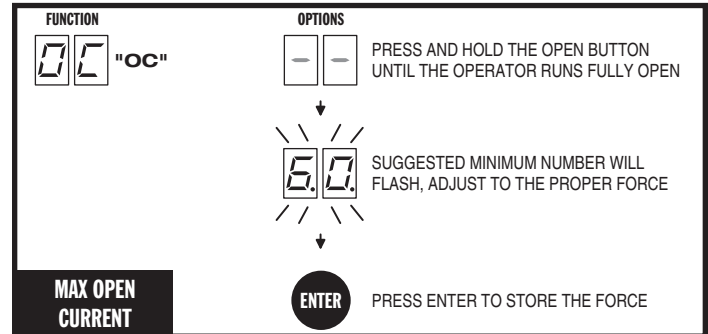
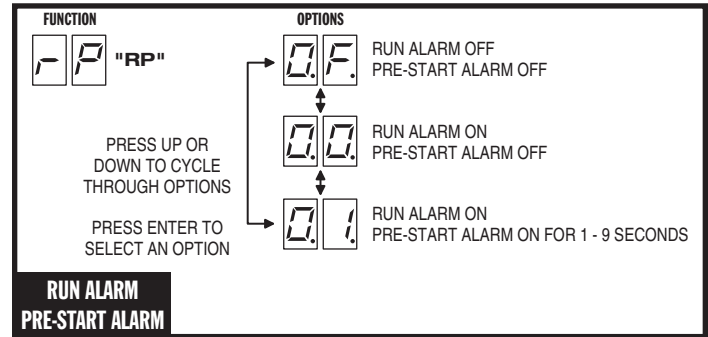

# Advanced Controller Programming

## Entering Advanced Programming Mode

To access and program the Advanced Programming functions, for each programming session, Advanced Programming must be enabled.

After exiting programming, the Advanced Programming functions will be available on the programming display during the next programming session unless the operator has run 50 or more cycles. After that, Advanced Programming must be enabled again.

## Maximum Run Time

The factory default for the Maximum Run Time (MRT) is 99 seconds. When the operator starts, a timer will begin counting. If a open or close limit is not reached or an obstacle or reversing input is not received before the timer expires, the operator will stop, the unit locks out and the alarm sounds. The timer can be set for 10 to 99 seconds, but should be left at 99 in most applications. Setting it too close to the actual run time may cause the time to expire with changing ambient temperature, gate conditions, etc...

If AC is present and an open or close limit is not reached or an obstacle or reversing input is not received before this timer exceeds MRT, the operator will stop, the unit locks out and the alarm sounds.

## Single Button Input Setup

This function is used for selecting the operation for single button controls and radio receivers.

The factory default sets the **SINGLE** input terminal so successive inputs will cycle the operator in OPEN-STOP-CLOSE-STOP order.

Alternately, the **SINGLE** input can be set to cause the gate to OPEN unless the gate is fully open. If the gate is fully open, the input will cause the gate to CLOSE.

## Stagger Mode

This function is used in dual gate installations only. The factory default sets the Stagger Mode to OFF. In dual gate installations the two operators communicate through the 3-wire **COMM LINK** interface. When using the Stagger Mode, set one operator for delayed opening and the other operator for delayed closing. The Stagger Time programming function (see below) sets the length of the delay.

✓ **NOTE:** This function will only be displayed if dual gate operation is selected.

## Stagger Delay Time

This function is used in dual gate installations only. The factory default sets the Stagger Time to 0 seconds (OFF). The Stagger Time sets the delay for the Stagger Mode. The Stagger Delay Time can be set from 1-99 seconds.

✓ **NOTE:** This function will only be displayed if dual gate operation is selected.

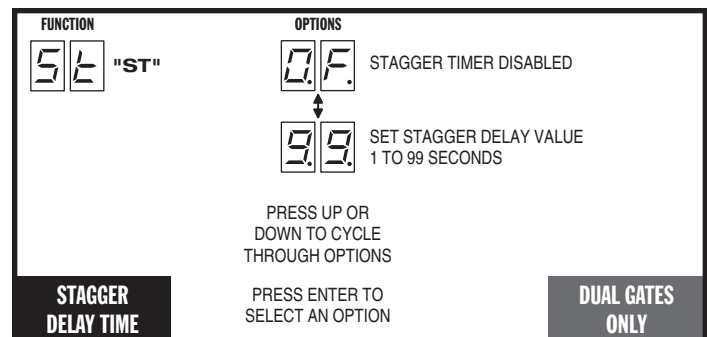
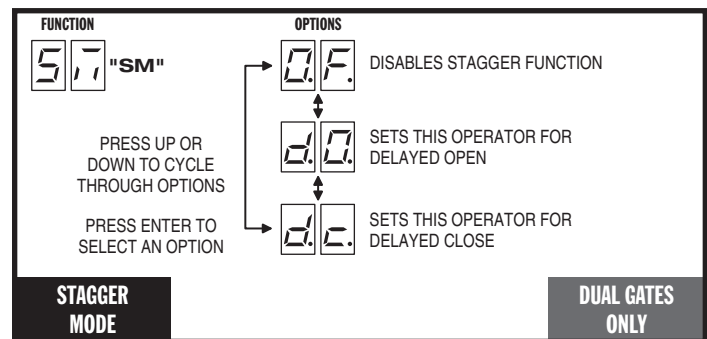
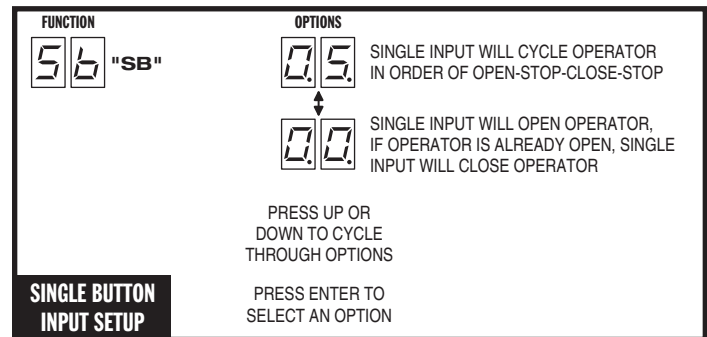
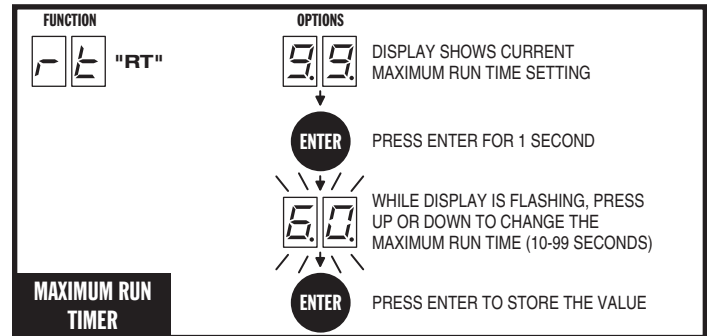
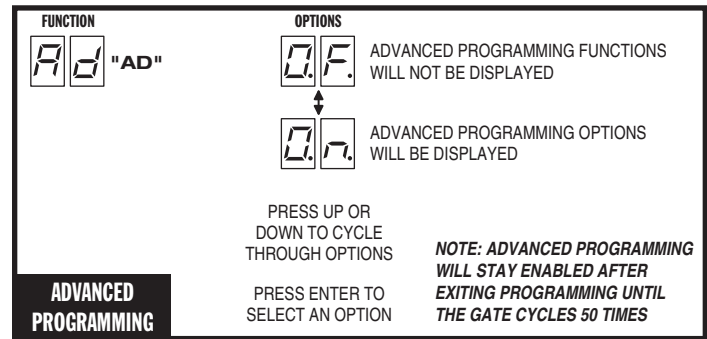



## Advanced Controller Programming (Cont.)

### Auxiliary Relay Mode

The Auxiliary Relay has normally open and normally closed contacts. The factory setting disables the Auxiliary Relay. The relay can be set for:

- **Maglock:** To deactivate a magnetic or solenoid gate lock, the relay will energize during any pending or actual gate motion (open only).
- **M4:** To deactivate a magnetic or solenoid gate lock, the relay will energize during any pending or actual gate motion (open only). 3 seconds after the gate starts to move, the relay will de-energize. This option is used for higher current solenoid locks.
- **Ticket Dispenser:** The relay will energize while the gate is moving in the open direction and at the full open limit, or in an entrapment condition.
- **Strobe:** To activate a warning strobe light, the relay will energize during any pending or actual gate motion (either open or close).
- **Alarm:** The relay will energize if the gate is manually forced open from the full closed position.

### Reverse Delay Time

The factory default sets the Reverse Delay to 1 second. The operator will wait the length of the delay before reversing direction. This feature will not change the reversal time when the operator is responding to an entrapment condition from an obstruction input or inherent entrapment protection sensor. The Reverse Delay can be set from 1 to 9 seconds. Heaver gates require a longer delay to allow time for the gate to stop.

### Brake Delay Time

**This function is displayed, but only used in operators with mechanical brakes. The Model VS-GSWG does not have a mechanical brake.**

The factory default sets the Brake Delay to no delay (0 seconds). Heavy gates may require delayed braking to allow the gate to slow down before stopping it. The operator can be set to wait the length of the delay after running before applying the brake. The Brake Delay can be set from 0 to 3 seconds.

### Constant Pressure Mode

The factory default allows momentary pressure on a control station's **OPEN** or **CLOSE** button to cycle the operator. The controller can be set to require constant pressure on the **OPEN**, **CLOSE**, or both buttons to run the operator.

- ✓ **NOTE:** If a button is set for constant pressure, and it is released before the operator reaches the open or close limit, the operator will stop the gate at its current position.

### Shadow Loop Open Prevention

If the shadow loop is triggered, it always prevents the gate from *closing* if the Auto Close Timer activates or a **CLOSE** command is given while the gate is at the full open position.

The controller can also be set to prevent the gate from *opening* if the shadow loop is triggered while the gate is at the close limit position. This prevents a swing gate from opening into a vehicle if it's parked near the gate on the inside.

FUNCTION	OPTIONS
"AR"	AUXILIARY RELAY DISABLED
PRESS UP OR DOWN TO CYCLE THROUGH OPTIONS  PRESS ENTER TO SELECT AN OPTION	AUXILIARY RELAY USED FOR MAGLOCK CONTROL
	AUXILIARY RELAY USED FOR MAGLOCK OR SOLENOID CONTROL 3 SECOND DELAY TO RE-ENERGIZE
	AUXILIARY RELAY USED FOR TICKET DISPENSER CONTROL
	AUXILIARY RELAY USED FOR WARNING STROBE LIGHT
	AUXILIARY RELAY USED FOR CONNECTION TO ALARM DEVICE
<b>AUXILIARY RELAY MODE</b>	

FUNCTION	OPTIONS
"RD"	SET TIMER VALUE 1 TO 9 SECONDS
PRESS UP OR DOWN TO CYCLE THROUGH OPTIONS  PRESS ENTER TO SELECT AN OPTION	
<b>REVERSE DELAY TIME</b>	

FUNCTION	OPTIONS
"BD"	SET TIMER VALUE 0 TO 3 SECONDS
PRESS UP OR DOWN TO CYCLE THROUGH OPTIONS  PRESS ENTER TO SELECT AN OPTION	
<b>BRAKE DELAY TIME</b>	

FUNCTION	OPTIONS
"CP"	CONSTANT PRESSURE SET TO OFF (MOMENTARY PRESSURE ON)
PRESS UP OR DOWN TO CYCLE THROUGH OPTIONS  PRESS ENTER TO SELECT AN OPTION	OPEN BUTTON SET FOR CONSTANT PRESSURE
	CLOSE BUTTON SET FOR CONSTANT PRESSURE
	OPEN AND CLOSE BUTTONS BOTH SET FOR CONSTANT PRESSURE
<b>CONSTANT PRESSURE MODE</b>	

FUNCTION	OPTIONS
"SP"	STANDARD OPERATION SHADOW LOOP INHIBITS CLOSING ONLY
PRESS UP OR DOWN TO CYCLE THROUGH OPTIONS  PRESS ENTER TO SELECT AN OPTION	OPEN INHIBIT ON, SHADOW LOOP INHIBITS OPENING AND CLOSING
<b>SHADOW LOOP OPEN PREVENTION</b>	

## Advanced Controller Programming (Cont.)

### Reset Cycle Count

The Controller counts of the number of times the operator has been cycled full open and close. The cycle count can be displayed. The display will scroll the cycle count number, flashing two digits at a time from left to right.

To reset the Cycle Count, press and hold the **ENTER** button for 2 seconds while the Cycle Count is displayed.

If the Maintenance Alert has been triggered, resetting the Cycle Count will also reset the Maintenance Alert indicator.

### Maintenance Alert Trigger

The Controller has a **MAINT ALERT** indicator that can be programmed to light when the number of activations exceeds a set number of cycles.

The factory default sets the Maintenance Alert Trigger to 10,000 cycles. The Maintenance Alert Trigger can be programmed for 5, 10, 15, or 25 thousand cycles.

The Maintenance Cycle Count can be reset independently from the operator's absolute Cycle Count.

### Mid-travel Stop Position

The Controller can be programmed so the gate will stop at a mid-travel point instead of fully opening. This can be useful in installations where a large gate, that takes a long time to open and close fully, only needs to be opened partway to allow traffic to pass.

The factory default sets the Controller for full open operation. Alternately, the Controller can be programmed to open for 1 to 99 seconds then stop, before reaching the open limit.

When a Mid-travel Stop Position time has been programmed, the gate will **still fully open** if the Fire Department input is triggered, if the **OPEN** button is held down beyond the Mid-travel Stop Position, or a close obstruction or reverse loop input is triggered.

✓ **NOTE:** The Mid-travel Stop feature is disabled when dual gate operation is enabled for paired units.

### Anti-tailgate Enable

The factory default sets the Anti-tailgate Enable to OFF. With this setting, during a gate cycle, after the shadow loop has been triggered by the vehicle and then has cleared after the vehicle passes, the Auto Close Timer or a CLOSE command is required to begin closing the gate.

If the Anti-tailgate Enable is set to ON, the gate will close immediately as soon as the shadow loop has cleared. Any subsequent shadow loop triggers while the gate is closing will stop the gate. When the shadow loop clears, the gate will continue closing.

### Radio Enable

The Controller contains a built-in MegaCode® radio receiver to allow activation from up to 40 access control transmitters and two Model MGT (gate edge) transmitters. The factory default enables the internal radio receiver. Alternately, the internal receiver can be disabled.

### Antenna Installation

The Controller is supplied with a local whip antenna installed. If using a remote antenna, remove the whip antenna and connect coax cable from the antenna to the **ANTENNA** connector.

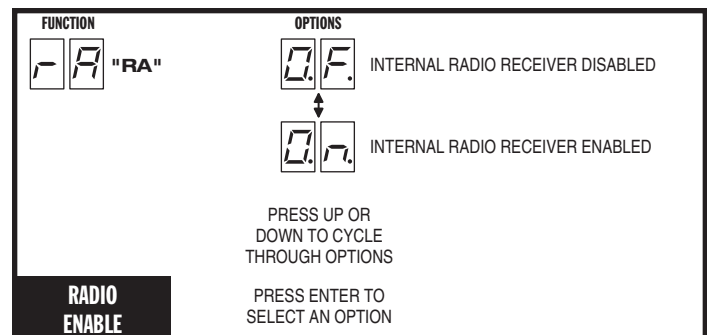
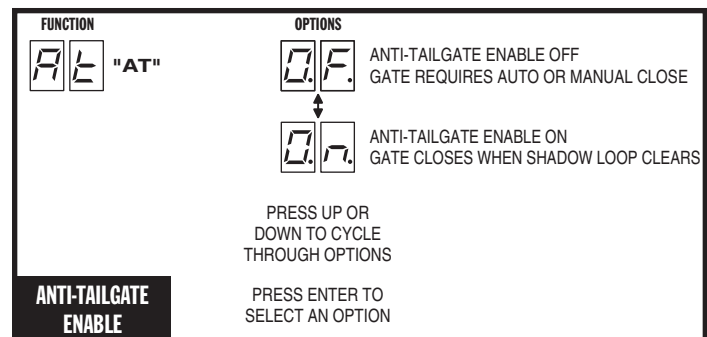
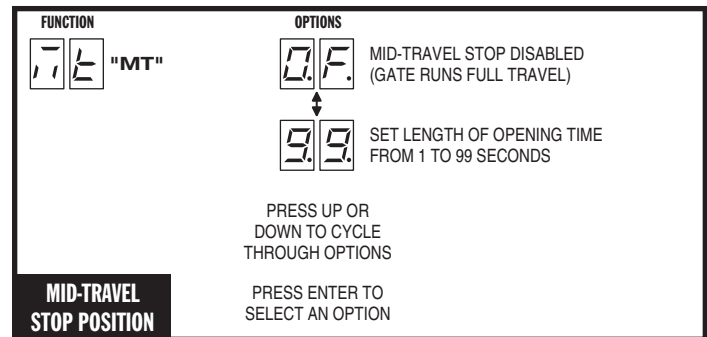
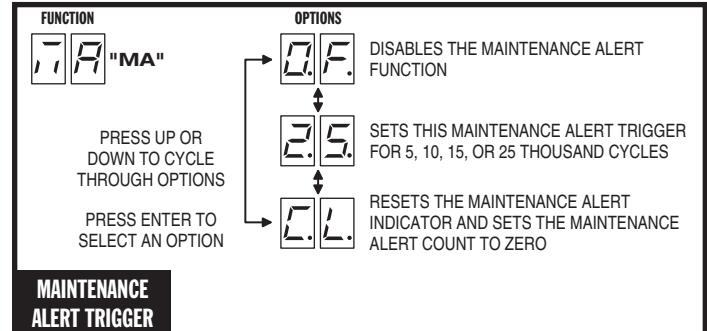
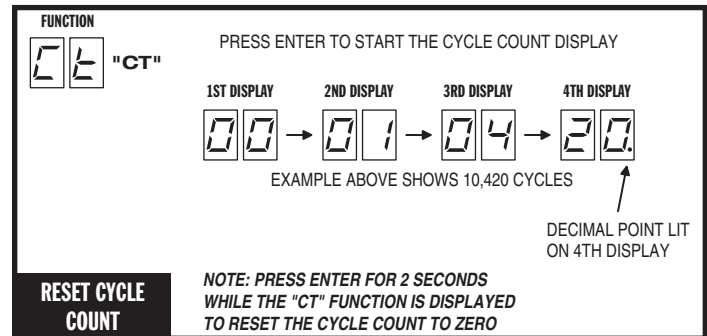

# Advanced Controller Programming (Cont.)

## Radio Transmitter Learn

The Controller's built-in MegaCode® radio receiver can store the IDs of up to 40 transmitters. Refer to the figure for the steps required to learn transmitters.

✓ **NOTE:** This function will NOT be displayed if the transmitter memory is full, or if the radio receiver is disabled.

## Radio Transmitter Delete

Transmitters can be deleted from the Controller's memory either individually, or all at the same time. Refer to the figure for the steps required to delete transmitters.

✓ **NOTE:** This function will NOT be displayed if no transmitters are stored in memory, or if the radio receiver is disabled.

## MGT Obstacle Transmitter Learn

The Controller supports one or two Model MGT Obstacle Transmitters. The transmitters can be programmed to function as Open Obstruction, Close Obstruction, Reverse, or Stop. Refer to the figure for the steps required to learn MGT transmitters.

✓ **NOTE:** This function will NOT be displayed if two MGT transmitters are already stored in memory, or if the radio receiver is disabled.

## MGT Obstacle Transmitter Delete

MGT transmitters can be deleted from the Controller's memory either individually, or all at the same time. Refer to the figure for the steps required to delete MGT transmitters.

✓ **NOTE:** This function will NOT be displayed if no MGT transmitters are stored in memory, or if the radio receiver is disabled.

## Motor Type Selection

The factory sets the default for the Controller to match the type of motor in the operator. If required, change the motor selection option to a different type of motor used in the operator. The options available are:

- AC Motor Only
- DC Motor Only with Mechanical Braking
- DC Motor with Electronic Soft Start/Stop
- 3 Phase AC Motor
- AC Motor with DC Motor Backup with Mechanical Braking
- AC Motor with DC Motor Backup with Electronic Soft Start/Stop

## Reset Controller to Factory Defaults

The Controller can be reset with this function. **ALL PROGRAMMED DATA WILL BE LOST**, and the factory defaults will be loaded. This function will not erase radio transmitters, current sense values, or motor type. Transmitters must be deleted with the two functions above.

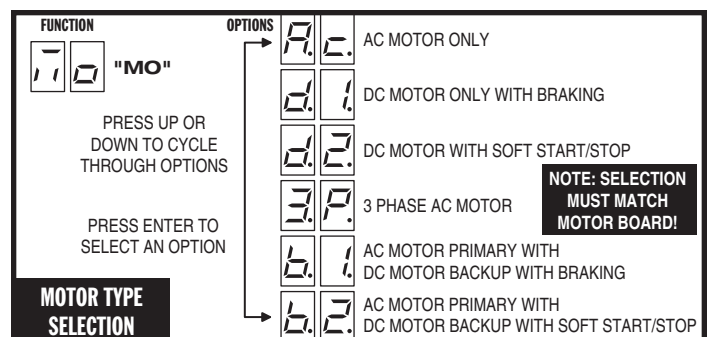
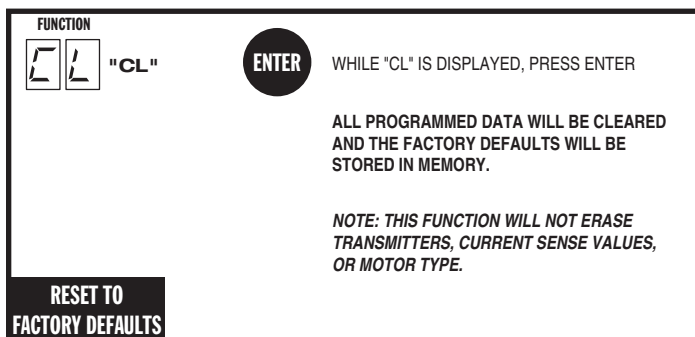
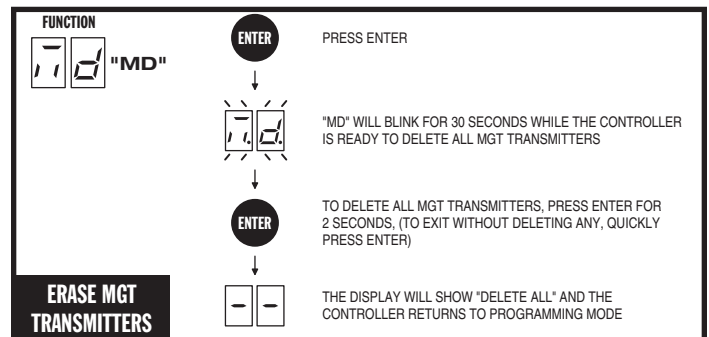
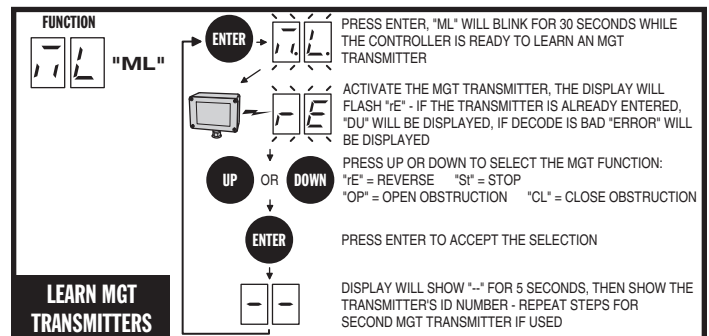
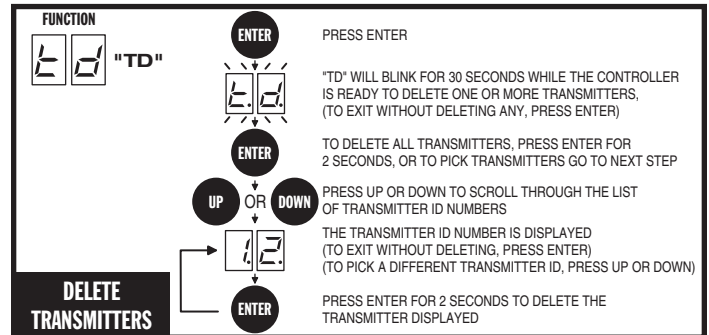
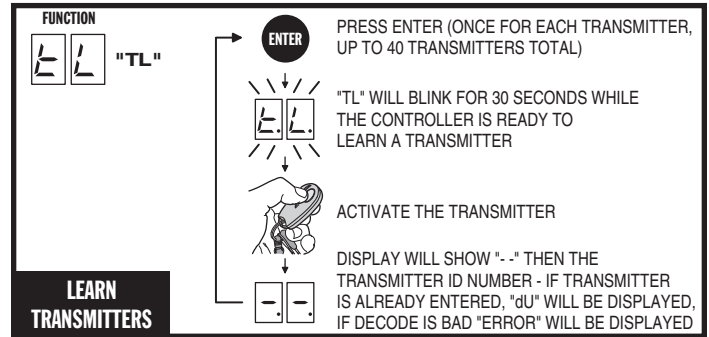

# Loop Layout Illustration

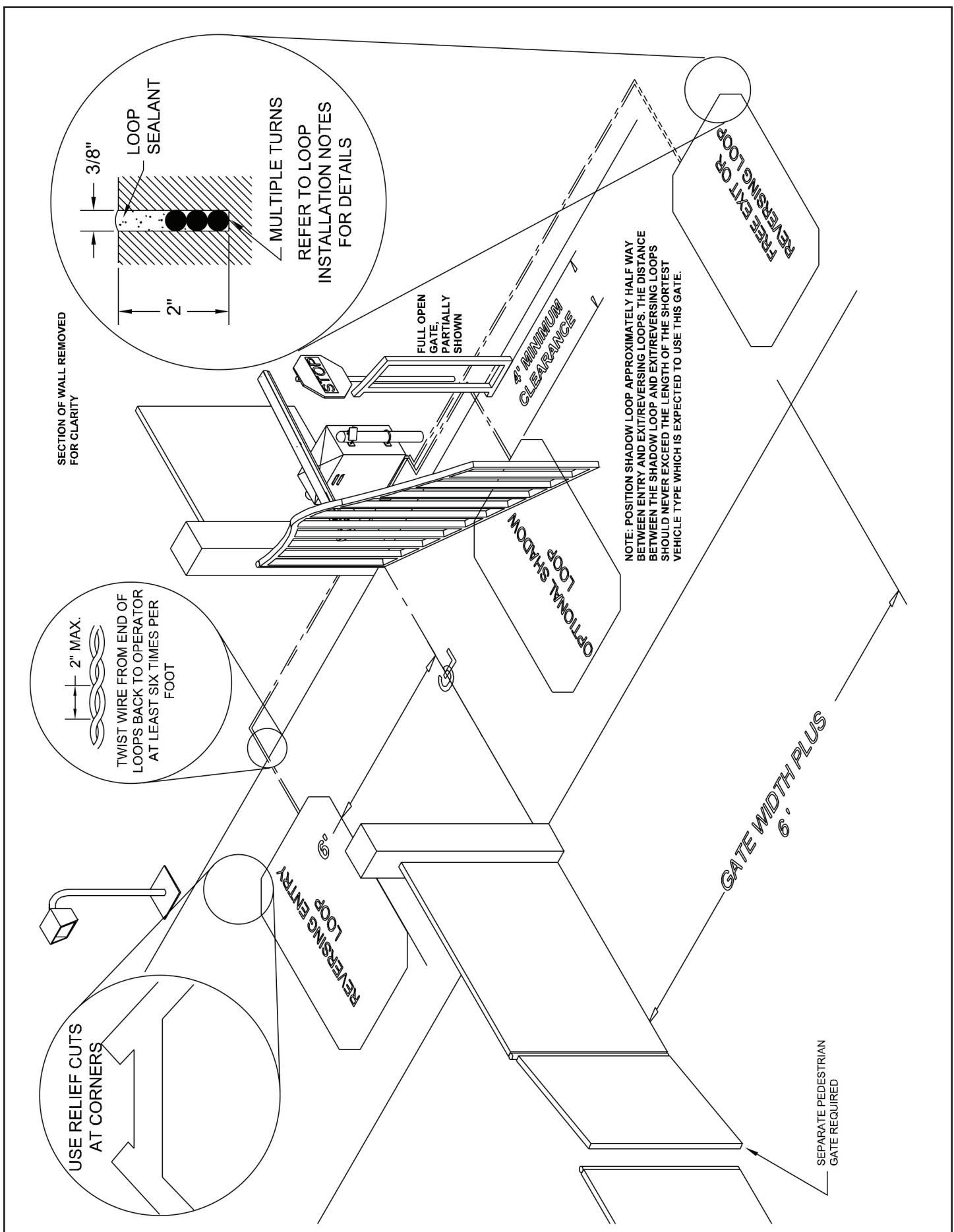

# Safety Edge Layout Illustration

**! WARNING !**  
 One or more contact sensors shall be located on the inside and outside leading edge of a swing gate. Additionally, if the bottom edge of a swing gate is greater than six inches (152 mm) above the ground at any point in its arc of travel, one or more contact sensors shall be located on the bottom edge. A hardwired contact sensor shall be located and its wiring arranged so that the communication between the sensor and the gate operator is not subjected to mechanical damage. A wireless contact sensor such as one that transmits radio frequency (RF) signals to the gate operator for entrapment protection functions shall be located where the transmission of the signals are not obstructed or impeded by building structures, natural landscaping or similar obstruction. A wireless contact sensor shall function under the intended end-use conditions.

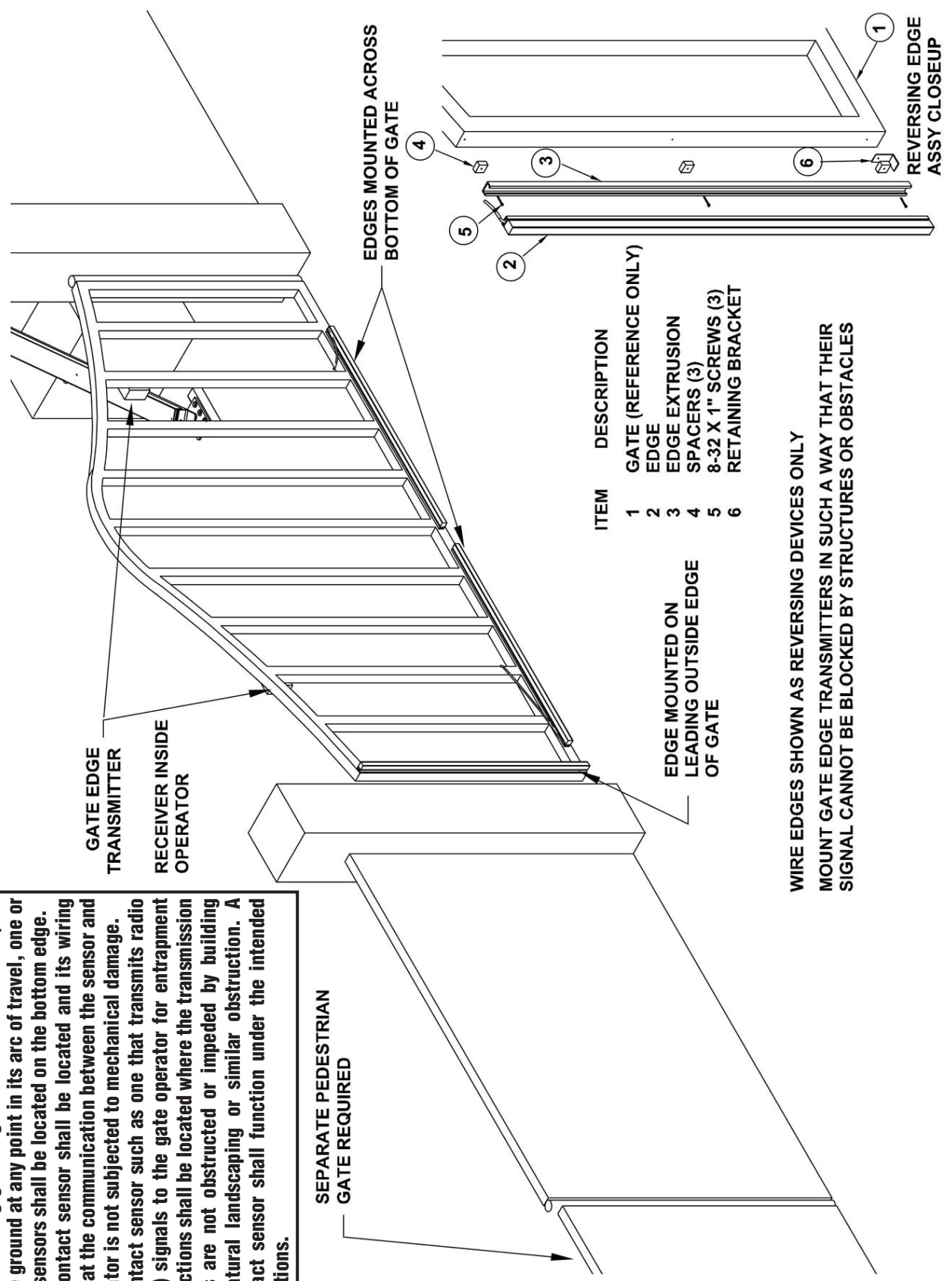

ITEM	DESCRIPTION
1	GATE (REFERENCE ONLY) EDGE
2	EDGE MOUNTED ON LEADING OUTSIDE EDGE OF GATE
3	EDGE EXTRUSION
4	SPACERS (3)
5	8-32 X 1" SCREWS (3)
6	RETAINING BRACKET

WIRE EDGES SHOWN AS REVERSING DEVICES ONLY  
 MOUNT GATE EDGE TRANSMITTERS IN SUCH A WAY THAT THEIR SIGNAL CANNOT BE BLOCKED BY STRUCTURES OR OBSTACLES

# Photoeye Installation Illustration

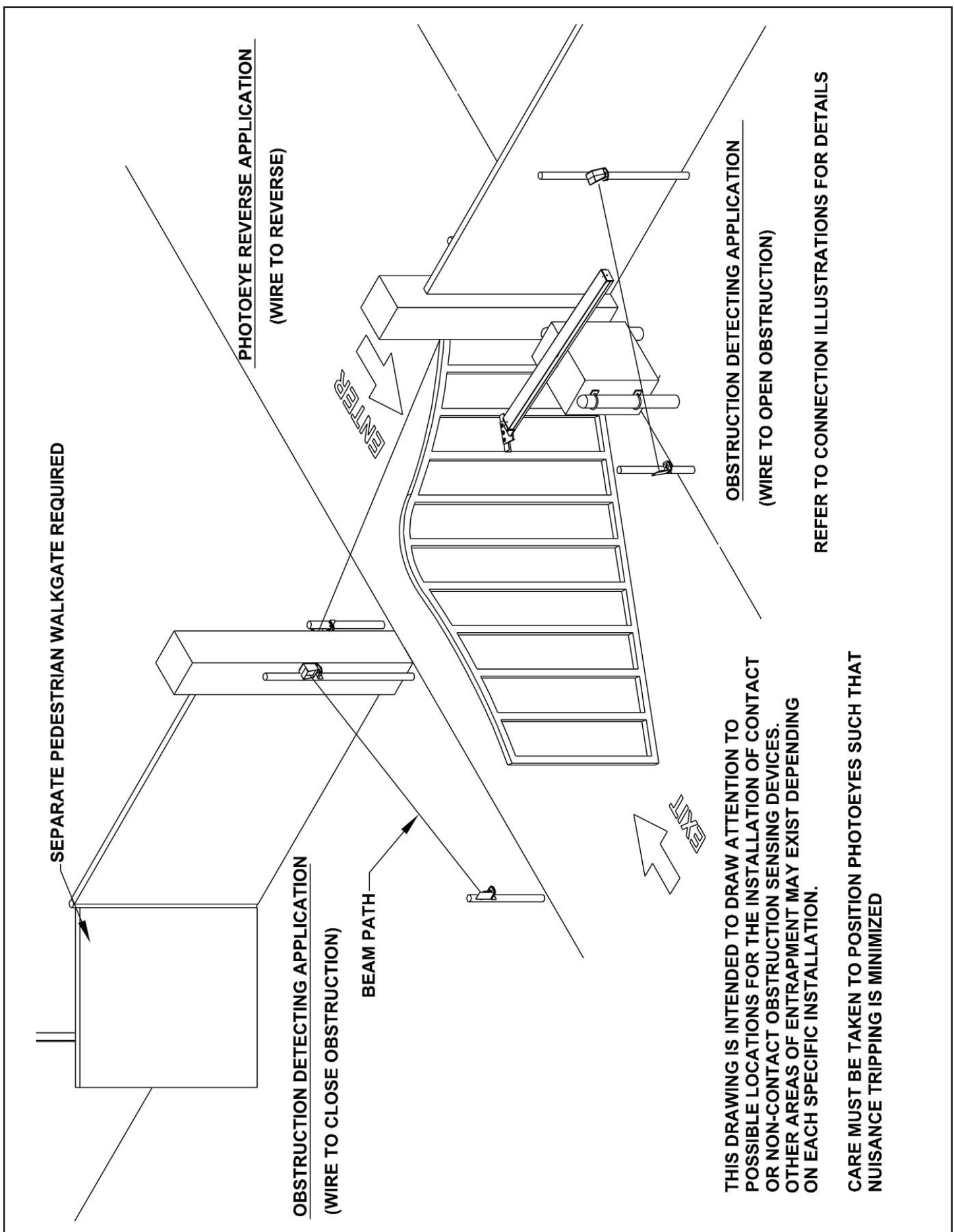

## Dual Gate Installations

Two operators can be used in dual gate installations. The operators communicate with each other through the 3-wire **COMM LINK** terminals.

When one operator activates, the **COMM LINK** connection signals the other operator to activate. Each operator functions independently, controlling its gate and monitoring its inputs and accessories.

A three-wire shielded conductor cable is required to connect two operators together for dual operation. Use Belden 8760 Twisted Pair Shielded Cable (or equivalent) only – P/N 2500-1982, per foot).

✓ **NOTE:** The shield wire should be connected **COMM LINK** terminal "C" in both operators.

Three of the programming functions available are only used for dual gate installations:

- **Dual Gate Enable**

Dual Gate Enable must be set for all dual gate installations.

- **Stagger Mode**

The Stagger Mode function determines if the operator has a delayed open or a delayed close. In dual swing gate installations, typically one operator is programmed for delayed open, and the other operator is programmed for delayed close.

- **Stagger Delay Time**

The Stagger Time sets the length of the delay for the Stagger Mode.

See Pages 12 & 14 for details on these three dual gate programming functions.

Set the following parameters in each gate operator individually in a single gate mode before connecting the network cable and operating in dual gate mode.

1. Open and Close Limit settings
2. Open and Closed direction inherent entrapment protection (OC & CC)

After these parameters have been set, and each operator has been tested independently and is functioning correctly in single gate mode, then set **BOTH** operators to dual gate (dg) in the Paired Mode setup step under Basic Programming steps.

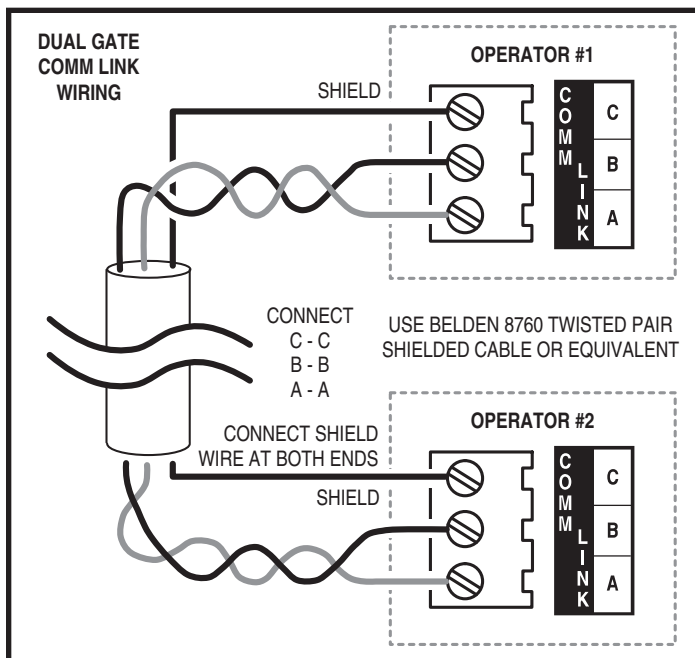

Figure 13. COMM LINK Wiring

## Optional In-Cabinet Heater

The operator can be ordered with an optional cold weather package that includes an in-cabinet heater to keep the drive train and electronics warm in cold environments.

In-cabinet heaters can also be ordered separately and should be wired to the operator as shown in Figure 14 Contact Technical Services for heater wiring information for a specific voltage and phase of operator.

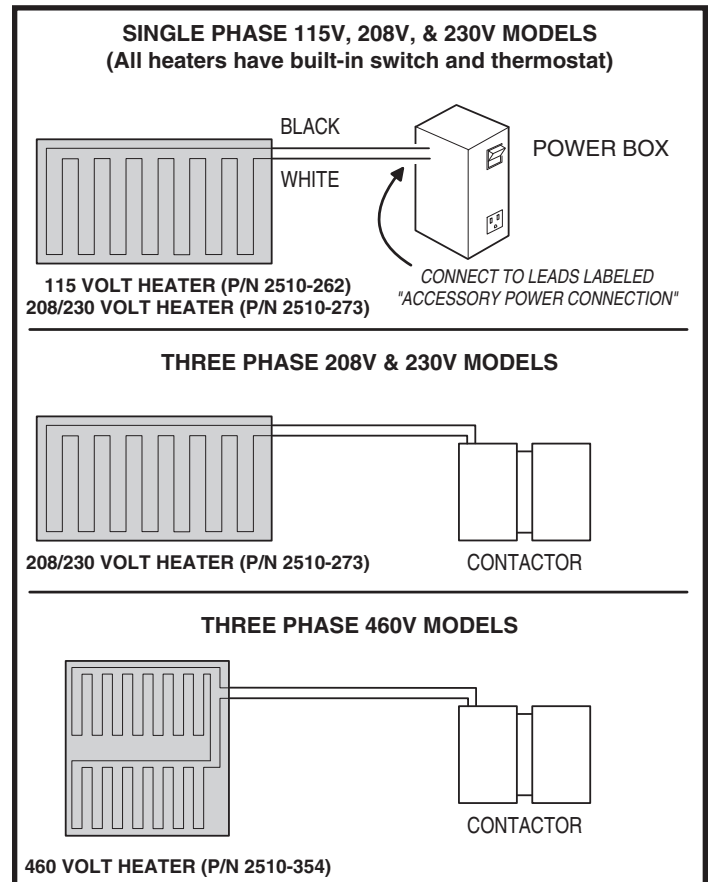

Figure 14. In-cabinet Heater Wiring

## Gate Operation

---

### **Open Button**

Opens the gate. If the Controller is programmed to stop opening the gate at mid-travel, a constant press of the **OPEN** button will override the Mid-travel Stop and completely open the gate. If the Auto Close Timer is set, it will be suspended until the **OPEN** button is released.

### **Close Button**

Closes the gate if the gate is open. Also closes the gate if the gate is in the process of opening.

### **Stop Button**

Stops the gate from opening or closing at any time.

### **Single Input**

Opens the gate if it's closed and closes the gate if it's open (open-close programming option). Activating the input while the gate is moving will reverse the gate.

Can be programmed to stop the gate while the gate is moving (open-stop-close programming option).

### **Fire Department Input**

Fully opens the gate when the input is activated. Overrides the Mid-travel Stop and Auto Close Timer (if either is programmed for the gate). The gate will lockout in the open position without sounding the alarm. Press the **STOP** button to release the lockout.

### **Open Input**

Functions the same as the **OPEN** button.

### **Open Obstruction**

While the gate is opening, any open obstruction signal will cause the gate to stop, reverse a short distance, and then stop again. The Auto Close Timer will be disabled, and a renewed input will be required to start the gate again. Should the gate be restarted and the obstacle signal occur again prior to reaching a limit, the gate will stop again, lockout, and sound the emergency alarm.

### **Close Obstruction**

While the gate is closing, any close obstruction signal will cause the gate to stop, reverse, and travel to the full open position. Should a open obstruction input or an open direction inherent entrapment condition occur prior to the gate reaching the open limit, the operator will lockout and sound the continuous tone alarm. Another close request will be required to start the operator again. If after restart, the overload or a close obstacle happens again before the close limit is reached, the operator will lockout and sound the alarm. If the auto close timer is set, when the close obstruction input is cleared, the gate will close when the auto close timer expires.

### **Reverse Input**

If the reverse input is triggered while the gate is closing, the gate will reverse to the full open position. If the Auto Close Timer is set, when the reverse input is cleared, the gate will close when the Auto Close Timer expires.

### **Open Loop**

Functions the same as the **OPEN** button.

### **Reverse Loop**

Functions the same as the reverse input.

### **Shadow/Reset Loop**

Holds the gate fully open or fully closed while triggered. If open, the gate closes immediately when cleared if Anti-tailgate is enabled.

## Operation Indications

---

During normal operation, the Controller's displays will indicate current operating conditions and status.

### **Power-up Display**

When the Controller powers up, dashes will show on the display, then the firmware version number, then the gate type (SL for slide and swing gates).

Exiting programming restarts the Controller. The power-up display will show upon the restart.

### **Idle Condition**

While the Controller is idling, waiting for a command, the display will show circulating dashes.

### **Last Gate Position/Condition**

When the gate moves or stops, the display will show the status for up to one minute.

- Stop is displayed as  $S\bar{E}$
- Full Close is displayed as  $F\bar{C}$
- Full Open is displayed as  $F\bar{O}$
- Entrapment is displayed as  $E\bar{n}$

### **Pre-start Delay**

During the pre-start delay, the display will countdown the number of seconds remaining before the operator starts.

### **Reverse Delay**

If the gate travel direction is reversed from a user activation or reversing device, and a reverse delay is set, the display will count down the delay time in seconds before the operator restarts.

### **Run Timer**

While the gate is opening or closing, the number of seconds running time is displayed.



## Error Indications

During abnormal operation, the Controller's displays and beeper will indicate the error condition that has occurred.

### Entrapment

If an entrapment condition occurs detected by two repeated open or close obstruction triggers, the Controller will lock the operator out. The beeper will sound constantly and the gate will not operate. To reset the Controller press the **STOP** button or press the **RESET** button on the operator's cover.

 <b style="font-size: 1.2em;">WARNING</b> 
<p><b>The Stop and/or Reset button must be located in the line-of-sight of the gate. Activation of the reset control shall not cause the operator to start.</b></p>

### COMM LINK Connection Failure

In dual gate installations, if there is a connection failure between the two operators, the **COMM LINK** indicator will blink once a second. During this condition the gate will not operate, except if triggered by the **FIRE DEPT** input, which functions normally.

### MGT Obstacle Transmitter Trouble

If any MGT transmitters are used with the operator, their supervision feature will alert the Controller if there is any trouble with the transmitter. MGT transmitters send hourly status reports and will send low battery reports when the transmitter has a low battery. The MGT transmitters also have a tamper detection switch that will trigger when their case is opened.

When the Controller detects a low transmitter battery, a tamper signal, or missing transmitter status reports, the gate will still operate normally, but the beeper will change as follows:

- The Pre-start Alarm will beep twice as fast.
- The Run Alarm will beep twice as fast and continue for five minutes after the gate stops.
- The sounder will "chirp" every five seconds when the gate is idle.

Correct the trouble (close case, replace battery, or replace transmitter) to clear the obstacle transmitter trouble indications.

### Maximum Run Time Exceeded

If the Maximum Run Time is exceeded, the Controller stops the operator the same as if a double obstacle has occurred in an entrapment condition. The entrapment alarm sounds constantly, and is cleared by pressing the **STOP** button or the **RESET** button on the cover. After the **STOP** or **RESET** button is pressed, because the Maximum Run Time has been exceeded, the sounder will beep twice every five seconds. The next operation of the gate will clear the indication.

CONTROLLER ERROR CAUSES AND INDICATIONS		
ERROR CAUSE	ERROR INDICATION	HOW TO CLEAR
TWO SAFETY REVERSALS (ON SINGLE GATE OR ON EITHER DUAL GATE)	E <sub>n</sub> 00, CONTINUOUS ALARM BEEPER, GATE DISABLED	PRESS STOP BUTTON
MAXIMUM RUN TIMER EXCEEDED ON OPENING	E <sub>n</sub> 01, AND MAX RUN LED, CONTINUOUS ALARM BEEPER, GATE DISABLED	PRESS STOP BUTTON, CLEARS CONTINUOUS ALARM, THEN DOUBLE BEEP EVERY 5 SECONDS UNTIL NEXT OPERATION
MAXIMUM RUN TIMER EXCEEDED ON CLOSING	E <sub>n</sub> 02, AND MAX RUN LED, CONTINUOUS ALARM BEEPER, GATE DISABLED	PRESS STOP BUTTON, CLEARS CONTINUOUS ALARM, THEN DOUBLE BEEP EVERY 5 SECONDS UNTIL NEXT OPERATION
COMM LINK FAILURE	E <sub>n</sub> 03, AND COMM LINK LED, CONTINUOUS ALARM BEEPER FOR 1 MINUTE, GATE DISABLED (EXCEPT FOR FIRE DEPT INPUT)	PRESS STOP BUTTON, CLEARS CONTINUOUS ALARM
GATE FULL OPEN RESULTING FROM FIRE DEPT INPUT	E <sub>n</sub> 04, GATE DISABLED	PRESS STOP BUTTON
FAIL SAFE OR FAIL SECURE BECAUSE OF BATTERY VOLTAGE DROP BELOW 21.6 VDC DUE TO AC POWER LOSS	E <sub>n</sub> 05, GATE DISABLED	BATTERY VOLTAGE MUST RISE ABOVE 24 VDC
OTHER CONTROLLER IN ENTRAPMENT (DUAL GATE)	E <sub>n</sub> 06, GATE DISABLED	CLEAR ENTRAPMENT ON OTHER CONTROLLER (PRESS STOP)
LOW AC VOLTAGE AT CONTROLLER	E <sub>n</sub> 07, GATE DISABLED	RESTORE AC POWER TO NORMAL LEVEL
INPUT TRIGGERED DURING ENTRAPMENT LOCKOUT	E <sub>n</sub> 08, GATE DISABLED	PRESS STOP BUTTON
COMPATIBILITY PROBLEM	E <sub>n</sub> 09, GATE DISABLED	UPDATE FIRMWARE AND RESET BOTH PAIRED CONTROLLERS
EEPROM PROBLEM	E <sub>n</sub> 10, GATE DISABLED	TRY RESET, CALL TECH. SUPPORT
DC MOTOR MISMATCH	E <sub>n</sub> 11, GATE DISABLED	REPROGRAM MOTOR TYPE OR CHANGE DC MOTOR BOARD, NEXT GATE MOVEMENT WILL RETRY DC MOTOR CHECK
MOTOR FAILURE	E <sub>n</sub> 12, GATE DISABLED	CALL TECH. SUPPORT
AC POWER LOSS IN OPEN OR CLOSE IMMEDIATE POWER FAIL MODE	E <sub>n</sub> 13	REAPPLY AC POWER
MAXIMUM RUN TIMER EXCEEDED AFTER AC POWER LOSS	E <sub>n</sub> 14	BATTERY VOLTAGE MUST RISE ABOVE 24 VOLTS
MGT SUPERVISORY CONDITION (TAMPER, LOW BATTERY, MISSING HOURLY STATUS)	FAST BEEPS DURING PRESTART, FAST BEEP RUN ALARM, CHIRP EVERY 5 SECONDS AT IDLE	CLEARS WHEN MGT CONDITION CLEARS

## Troubleshooting

### Contacting Technical Support

For technical questions regarding Linear gate operators, contact the Technical Services Department at:

**1-800-421-1587 from 5:00 AM to 4:30 PM Pacific time**

### Operator fails to start

- A. If the operator has been running a large number of cycles, the motor may have become too hot and tripped its thermal overload breaker. Allow the motor to cool down and the thermal overload breaker will reset automatically.
- B. Make sure you have power at the master distribution panel and that the power has not been turned off.

### Motor operates, but gate does not move

- A. In operators with torque limiters and friction pad clutches, check for signs of slipping. You can mark the sprocket and clutch with a yellow or white grease pen and watch for the lines to move apart if slipping is taking place. Adjust the torque limiter tighter if this is the problem.
- B. Check for broken chain or worn belts.
- C. Check all setscrews on pulleys and sprockets and tighten them if necessary, and check for keys which may have fallen loose from keyways.

### Motor sounds like it is working harder than normal

- A. Make sure the gate is moving freely and without binding throughout its entire travel.
- B. Check the drive chain for obstructions (if the operator has one).
- C. If the operator has an internal brake mechanism, make sure it is releasing.

### Limit switch getting out of time

- A. Check the setscrews in limit cams for tightness. Replace if necessary.

### Gate stopping part way open or closed (but no visible obstruction)

- A. The Controller may have received a false obstruction input triggered by current sensing set too low. Make sure the gate moves freely through its entire travel before adjusting the current sensing.
- B. The Maximum Run Timer may have counted down and expired. This can be caused by having the timer set too low, if a chain or belt is broken, or if a sprocket or pulley is slipping. When the timer expires, the gate stops and the beeper will sound.
- C. An obstruction signal from an accessory wired to the obstruction input may have triggered falsely. Check the control board for lit indicators for any of the following inputs: safety, shadow/reset, open obstruction, close obstruction, stop, etc. If any are lit when the operator should be running, remove all devices hooked to that function and hook them up one at a time and try to run the operator until the problem device is found. Refer to Page 9 for details on the control board indicators.

### Gate staying open with automatic system

- A. If there are vehicle detectors used with the operator, one of the loops or loop detectors may be sending a false signal or needs to be reset. Observe the indicators on the loop detector. Unplug the detector and try running the operator.
- B. An opening or reversing device may be stuck or malfunctioning. Try disconnecting these devices and hook them back up one at a time and try running the operator until the malfunctioning device is found.
- C. Make sure the close limit switch isn't activated. If it is, the operator will think the gate is already closed.

### How to Order Replacement Parts

Use the part numbers listed on the following pages.  
Contact your local Linear dealer or distributor to order parts.

1. Supply the model number and serial number of your operator.
2. Specify the quantity of pieces needed and order by part number and name of part.
3. State whether to ship by freight, truck, parcel post, UPS or air express.
4. State whether transportation charges are to be prepaid or collect.
5. Specify name and address of person or company to whom parts are to be shipped.
6. Specify name and address of person or company to whom invoice is to be sent.

## Preventative Maintenance



**Always disconnect power from operator before servicing.  
Keep clear of gate during operation.**

### General

Linear gate operators are designed for many years of trouble-free operation and, under recommended operating conditions, will require only minimal maintenance. To ensure that a unit is ready for operation at all times, and to preclude serious damage or failure, inspect the unit systematically. Proper adjustments and lubrication should be made as recommended.

### Lubrication

- ✓ **Bearings** — For models which have pillow block style bearings with grease fittings, lubricate at least twice a year with a lithium complex based, petroleum oil NLGI 2 rated grease. Oilite and precision sealed bearings do not require additional lubrication.
- ✓ **Motor** — Motors have sealed ball bearings and do not require further lubrication. If bearing noise develops after several years of operation, bearings should be replaced by a motor repair company, or the motor should be replaced if necessary.
- ✓ **Swing Gate Arm** — Check all bolts for proper tension and tighten if necessary. Lightly lubricate all pivot points with a light machine oil.

## 6-Month Preventative Maintenance

1. For operators which utilize torque limiting clutches, check for proper tightness. If there appears to be dust from wear on the pads, inspect the pads and replace if necessary. If the clutch cannot be adjusted tightly enough to move the gate without slipping, the pads must be replaced.
2. For operators with V-belts, inspect for wear and replace as necessary. Check for proper tension and adjust if required. Check all pulley setscrews for tightness and tighten if necessary.
3. For operators with internal chain drives, inspect chain and sprockets for wear and replace if necessary. Check for proper tension and alignment, and adjust if required. Check all hub sprocket setscrews and tighten if required.
4. Check limit switches and limit actuators (cams, limit nuts, etc.) for wear and replace as required. In rotary limit switch assemblies, wipe the limit shaft clean and apply a light coating of dry lubricant.
5. For operators with magnetic brakes, check for proper adjustment. Brake disc must run free when the brake is engaged. For brake assemblies other than C-face style, the brake should be adjusted so that the solenoid plunger throw is between 3/8" to 1/2". Too much throw will damage the solenoid. **If the solenoid emits a loud buzzing sound when the motor is run, the brake must be adjusted.**
6. In operators which have a disconnect handle, inspect disconnect handle for proper function and lubricate if necessary. Use a lithium based grease on all moving parts.
7. Inspect all nuts and bolts for proper tightness and tighten as necessary.
8. Check all reversing devices for proper function. Inspect all contact edges for wear and replace if required. Check photoeyes for proper alignment and function.
9. Check current sensing for proper adjustment when finished with inspection and maintenance.
10. Inspect the installation area. Are all the warning signs intact and visible? If they are missing or need replaced, contact Linear. Be sure there are no control stations mounted within reach of the gate. Review safety literature with the customer and advise them to remove any such stations found.

### FCC Notice

This device complies with FCC Rules Part 15 and Industry Canada Rules & Regulations. Operation is subject to the following two conditions: (1) This device may not cause harmful interference and (2) this device must accept any interference received, including interference that may cause undesired operation.

**For all gate operators, you must inspect the gate for proper operation. The gate should move easily without binding through its entire travel. If the gate does bind, adjust or fix as required. Failure to keep the gate in good working condition will have adverse effects on the operator.**

# Model VS-GSWG Exploded View

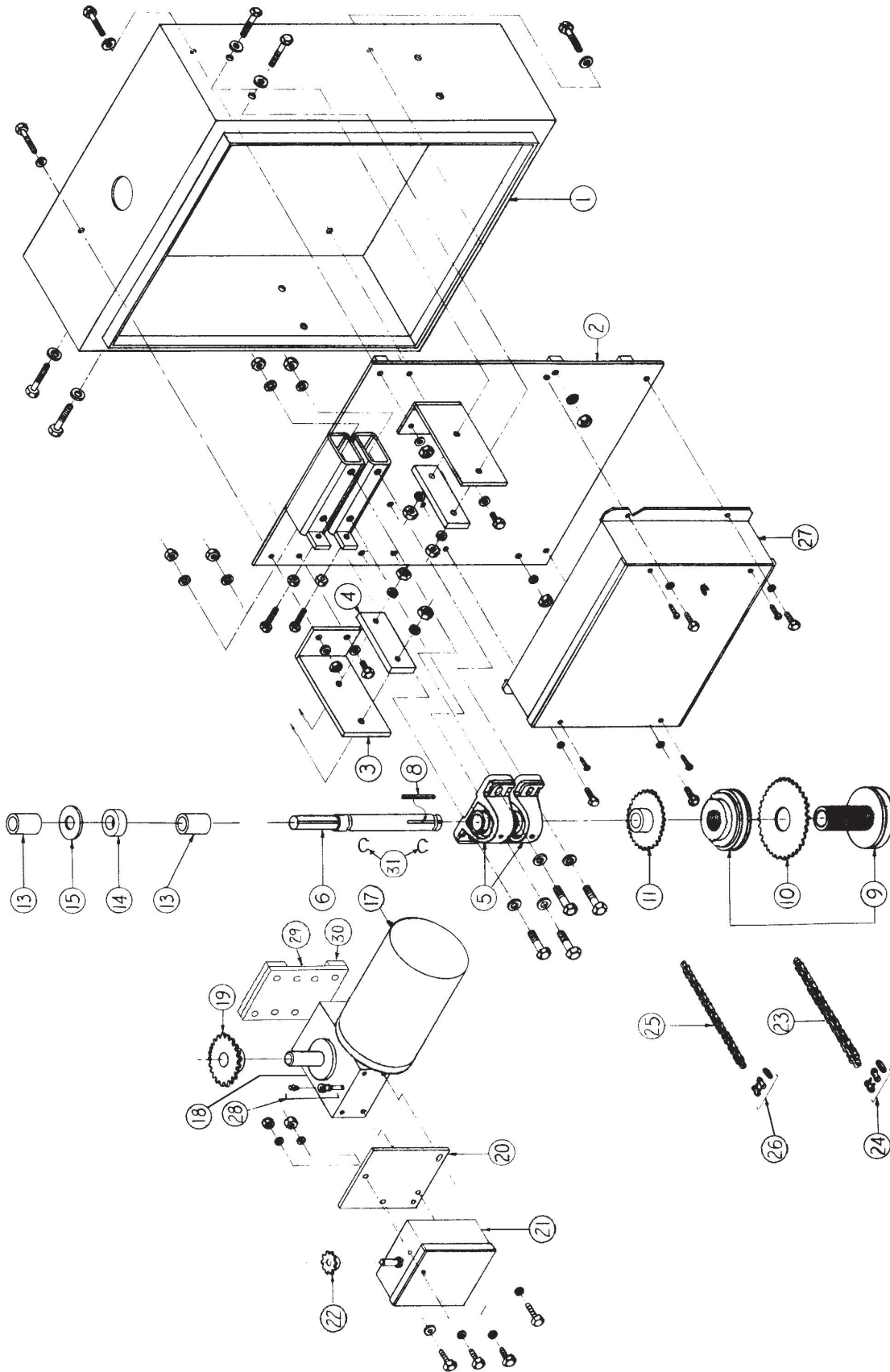

<b>MODEL SWG MECHANICAL PARTS LIST</b>		
<b>REF. #</b>	<b>PART #</b>	<b>DESCRIPTION</b>
	2120-361	Complete Enclosure Assembly with Door
1	2110-067	Enclosure Assembly without Door
	2120-362	Enclosure Door and Lock Assembly
	2110-643	Snap Lock Assembly only
2	2110-161	Mounting Panel Assembly
3	2100-708	Side Support Bracket
4	2100-656	Side Plate, 3/8"
5	2200-264	Pillow Block Bearing
6	2100-766	Drive Shaft, 1-1/8" diameter
8	2400-278	Key, 1/4" x 1/4" x 2-1/2"
9	2200-595	Torque Limiter, 5"
	2300-381	Torque Limiter Facing, 5"
10	2200-583	Sprocket, 40-A-36, 3" bore
11	2210-009	Sprocket, 48-B-30, 1-1/8" bore
13	2100-1112-PLT	Moisture Seal Spacer (2)
14	2200-016	Moisture Seal
15	2400-067	Seal Washer, 1" x 2-1/2"
18	2200-097	Gear Reducer, 60:1
19	2200-968	Sprocket, 40-B-22, 1" bore
20	2100-735	Limit Box Mounting Plate
21	2520-453	Rotary Limit Box Assembly
22	2200-008	Sprocket, 48-B-10, 1/2" bore
23	2200-459	#40 Roller Chain, 27 1/2 Links
24	2200-006	#40 Master Link
25	2200-200	#48 Roller Chain, 27 Links
26	2200-010	#48 Master Link
27		Complete Controller Assembly
28	2200-409	Pipe Nipple
29	2100-1414	Reducer Plate
30	2100-1413	Reducer Plate Spacer
	2200-428	Reducing Coupling
	2200-429	Pipe, 1/4" x 3 1/2" THD, both ends
	2400-264	Pipe Plug, 1/4"
	2510-064	Three-Button Station with Lead Wires
	2500-033	Three-Button Station only
31	2400-514	Retaining Ring Clip
		<b>C-Face Motors</b>
17	2500-2313	1/2 HP, 208/230/460V, 3 Phase
	2500-2315	1 HP, 208/230/460V, 3 Phase
	2500-372	2 HP, 208/230/460V, 3 Phase

# Controller Parts List

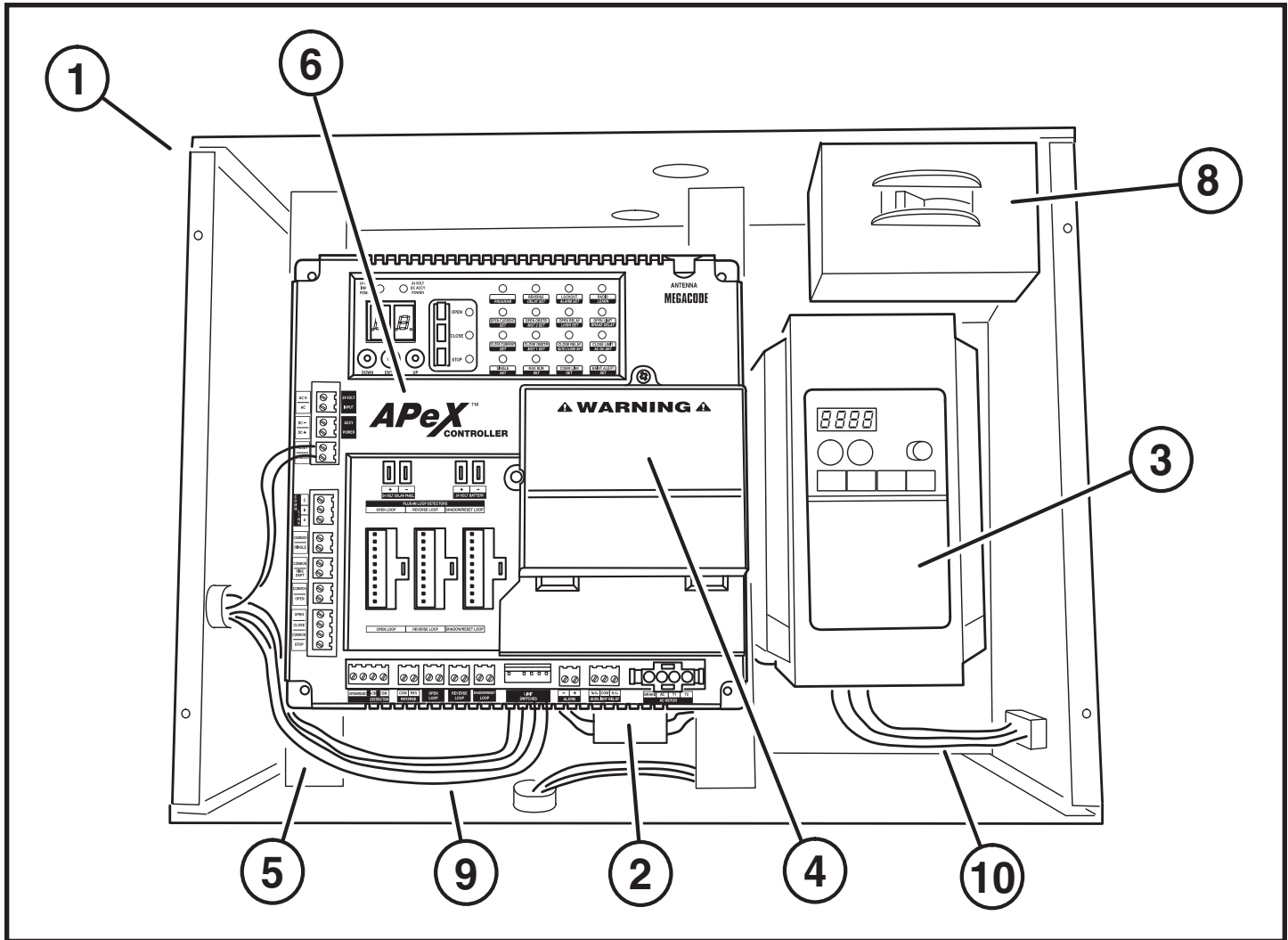

VS-GSWG CONTROLLER MECHANICAL PARTS LIST		
REF. #	PART #	DESCRIPTION
<b>Variable Speed Control Box Assemblies</b>		
	2520-543	1/2 HP, 115V, 1-Phase Controller
	2520-544	1/2 HP, 208/230V, 1-Phase Controller
	2520-545	1/2 HP, 208/230V, 3-Phase Controller
	2520-546	1/2 HP, 460V, 3-Phase Controller
	2520-547	1 HP, 115V, 1-Phase Controller
	2520-548	1 HP, 208/230V, 1-Phase Controller
	2520-549	1 HP, 208/230V, 3-Phase Controller
	2520-550	1 HP, 460V, 3-Phase Controller
	2520-551	2 HP, 208/230V, 1-Phase Controller
	2520-552	2 HP, 208/230V, 3-Phase Controller
	2520-553	2 HP, 460V, 3-Phase Controller
1	2120-447	Enclosure with Cover
<b>Transformers</b>		
2	2500-212	115V to 24V, 40VA
	2500-791	208/230V to 24V, 40VA
	2500-214	460V to 24V, 40VA

REF. #	PART #	DESCRIPTION
<b>Hitachi Controllers</b>		
3	2500-2244	1/2 HP, 115V, 1-Phase
	2500-2246	1/2 HP, 208/230V, 1-Phase or 3-Phase
	2500-2249	1/2 HP, 460V, 3-Phase
	2500-2245	1 HP, 115V, 1-Phase
	2500-2247	1 HP, 208/230V, 1-Phase or 3-Phase
	2500-2250	1 HP, 460V, 3-Phase
	2500-2248	2 HP, 208/230V, 1-Phase or 3-Phase
	2500-2251	2 HP, 460V, 3-Phase
<b>Apex Parts</b>		
4	2500-1980	3-Phase Motor Board
5	2100-2149	Apex Mounting Straps
6	2500-2393	Apex Module
<b>Power On/Off Switch, 30 Amp, 600VAC</b>		
8	2500-2291	Power On/Off Switch, 30 Amp, 600VAC
<b>Wiring Harnesses</b>		
9	2510-494	Limit Switch Harness
10	2510-500	Control Box Motor Harness, 115/230V
	2510-501	Control Box Motor Harness, 460V

## Variable Speed Drive Programming

### ⚠ CAUTION ⚠

This unit has been programmed at the factory. No changes should be necessary for normal operation. PLEASE CONSULT THE FACTORY BEFORE MAKING ANY CHANGES!

### Programming the Hitachi Inverter

1. Apply power
2. Press **FUNC**
3. Use ▲▼ arrows to advance to F\_\_ (**F002** for L200)
4. Press **FUNC** arrow to get to **F02** (L100 ONLY)
5. Press **FUNC**, arrows to change to **3.0** (**3.00** for L200), **STR**
6. Up arrow to advance to next parameter, (**F03**), **FUNC** to view, arrows to change, **STR** to store and continue, advance through listed parameters and store new values.
7. To switch from one letter prefix to another, press **FUNC** 3 times, advance to desired letter prefix, press **FUNC**, advance to desired parameter.
8. When all parameters have been changed, advance to **D01**, press **FUNC**, then press **STR**. This will display the operating speed in Hz. (**0-95**)

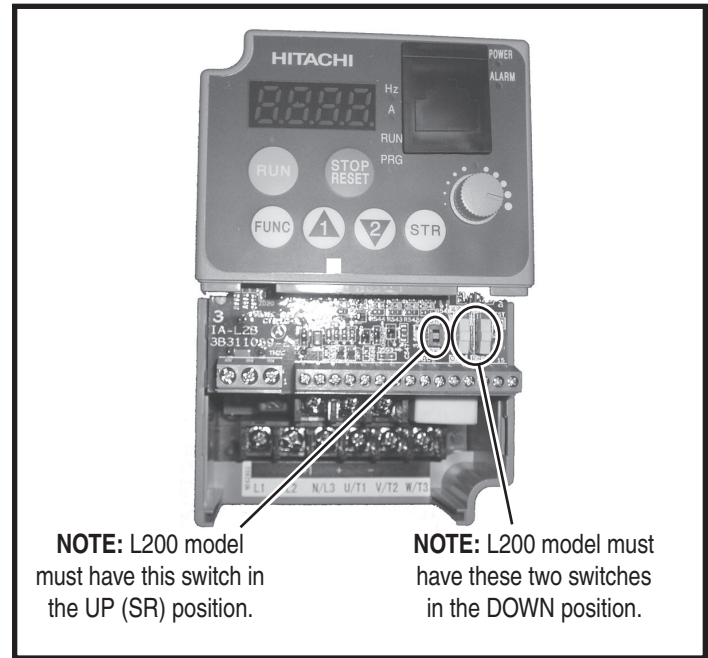
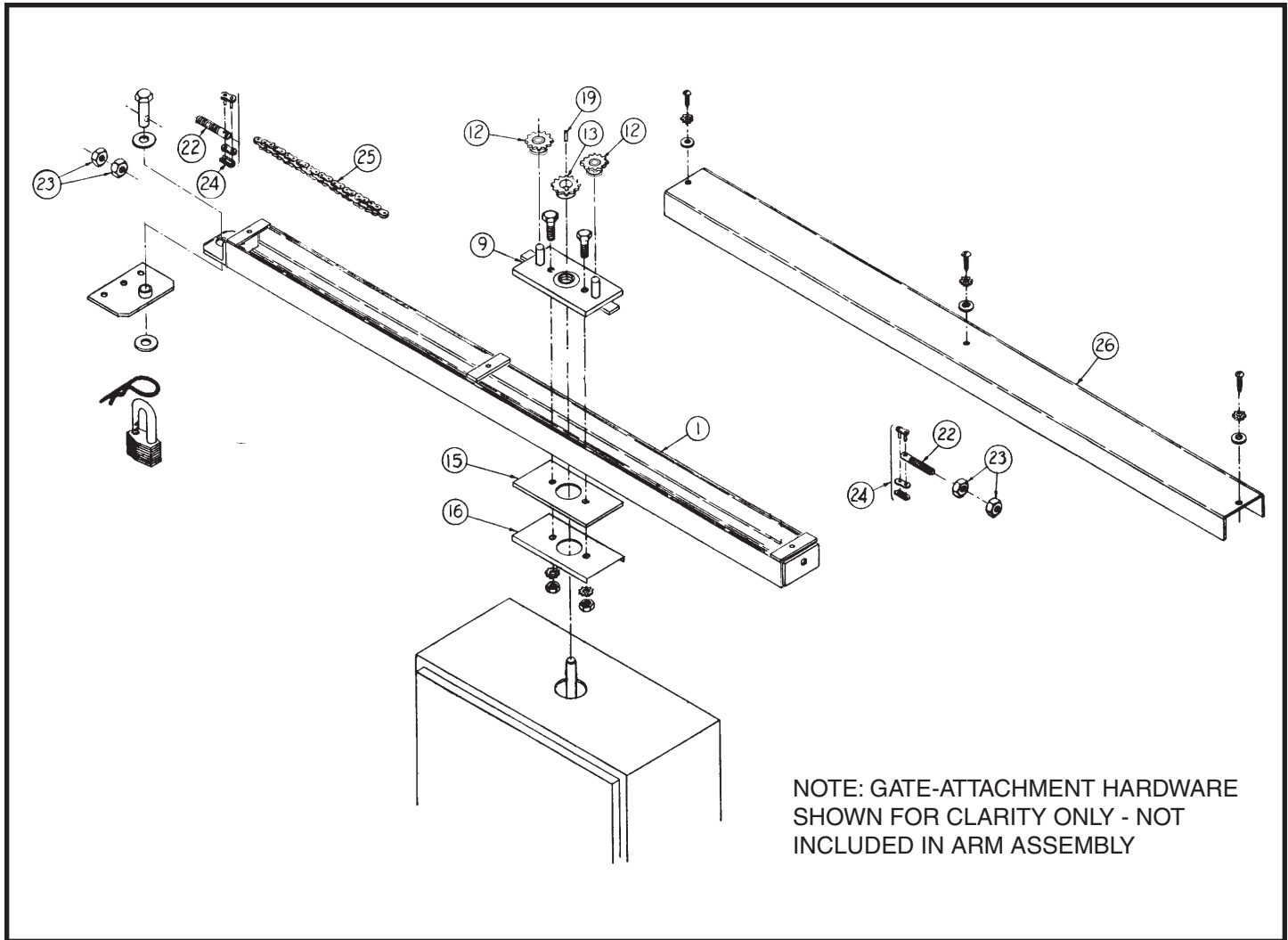

Figure 14. Hitachi L200 Inverter

### List of parameters set at factory

MODEL L100			MODEL L200		
FUNCTION	DESCRIPTION	RECOMMENDED SETTING	FUNCTION	DESCRIPTION	RECOMMENDED SETTING
F02	ACCEL TIME	3.0	F002	ACCEL TIME	3.00
F03	DECEL TIME	3.0	F003	DECEL TIME	3.00
A01	SPEED SOURCE	00 (POT)	A001	SPEED SOURCE	00 (POT)
A02	RUN COMMAND SOURCE	01	A002	RUN COMMAND SOURCE	01
A04	MAX SPEED	95.0 (Hz)	A004	MAX SPEED	95 (Hz)
A20	TARGET SPEED	95.0 (Hz)	A020	TARGET SPEED	95.0 (Hz)
A21	SECOND SPEED	20.0 (Hz)	A021	SECOND SPEED	20.0 (Hz)
			A042	AUTO TORQUE BOOST	0
			A044	BOOST PERCENT	00
			A081	AUTO VOLTAGE REGULATION	01
A62	MIN SPEED	20.0 (Hz)	A062	MIN SPEED	20.0 (Hz)
B01	AUTO RESET	01	B001	AUTO RESET	01
			B130	INHIBIT DECEL OVERVOLTAGE	01
C03	TERM 3 FUNC	03	C003	TERM 3 FUNC	03
C04	TERM 4 FUNC	11	C004	TERM 4 FUNC	11
			C014	TERM 4 STATE	01

# Gate Arm Assembly Parts List



GATE ARM ASSEMBLY MECHANICAL PARTS LIST		
REF. #	PART #	DESCRIPTION
	2110-648	Gate Arm Assembly, 78" (complete)
1	2110-312	Welded Rail Assembly, 78"
9	2110-248	Upper Rail Guide Assembly, with Bearing
12	2220-011	Sprocket, 40-B-13, 7/8" bore, with Bearing
13	2200-004	Sprocket, 40-B-13, 1" bore
14	2400-026	Spring Pin, 3/16" x 1"
15	2100-051	Lower Rail Guide
16	2100-052	Rain Cover
19	2400-004	Key, 1/4" x 1/4" x 1"
22	2100-054	Chain Tension Bolt
23	2400-015	Hex Nut, 3/8"-16
24	2200-006	#40 Master Link
25	2200-658	#40 Chain, 72 Links
26	2100-1168-BT	Cover for 78" Arm
<b>Parts for non-standard 63" VS-GSWG Gate Arm</b>		
	2110-257	Gate Arm Assembly, 63" (complete)
1	2110-271	Welded Rail Assembly, 63"
25	2200-420	#40 Chain, 57 Links
26	2100-1167-BT	Cover for 63" Arm



This page left blank intentionally.

# Gate Operator Installation Checklist

---

INSTALLER    CUSTOMER

- |                          |                          |                                                                                                                                                                                                                                                                                        |
|--------------------------|--------------------------|----------------------------------------------------------------------------------------------------------------------------------------------------------------------------------------------------------------------------------------------------------------------------------------|
| <input type="checkbox"/> | <input type="checkbox"/> | 1. The gate has been checked to make sure it is level and moves freely in both directions.                                                                                                                                                                                             |
| <input type="checkbox"/> | <input type="checkbox"/> | 2. Potential pinch areas have been guarded so as to be inaccessible <b>OR</b> have contact and/or non-contact obstruction sensing devices installed.                                                                                                                                   |
| <input type="checkbox"/> | <input type="checkbox"/> | 3. The installer has installed one or more contact or non-contact obstruction sensing devices, in compliance with UL325 requirements for this installation.                                                                                                                            |
| <input type="checkbox"/> | <input type="checkbox"/> | 4. If pedestrian traffic is expected, a separate pedestrian gate has been installed, a minimum of seven feet from the gate. The customer has been informed that <u>all pedestrian traffic must use the pedestrian gate.</u>                                                            |
| <input type="checkbox"/> | <input type="checkbox"/> | 5. Warning signs have been installed on each side of the gate in highly visible locations. The customer has been informed that these signs must remain at all times.                                                                                                                   |
| <input type="checkbox"/> | <input type="checkbox"/> | 6. There are no controls installed on the gate operator, or within seven feet of the gate.                                                                                                                                                                                             |
| <input type="checkbox"/> | <input type="checkbox"/> | 7. The installer has properly adjusted the obstruction sensing feature and has tested the gate to make sure that the gate stops and reverses a short distance with minimal resistance applied (40 lbs. on a swing gate at the end of the gate, 75 lbs. on a slide gate)                |
| <input type="checkbox"/> | <input type="checkbox"/> | 8. The installer has instructed the customer in the proper use of the gate operator and reviewed all of the operational functions, obstruction sensing devices, warning beeper and reset, etc.                                                                                         |
| <input type="checkbox"/> | <input type="checkbox"/> | 9. The installer has instructed the customer in the proper use of the operator's manual disconnect feature. The manual disconnect must never be used while the gate is in motion. The power switch must be turned off before using the manual disconnect and disengaging the operator. |
| <input type="checkbox"/> | <input type="checkbox"/> | 10. The installer has reviewed all safety instructions with the customer, and has left the safety instructions and owner's information sheets for their reference.                                                                                                                     |
| <input type="checkbox"/> | <input type="checkbox"/> | 11. The installer has answered any questions the customer has regarding the operation of the gate operator and gate operator safety precautions.                                                                                                                                       |
| <input type="checkbox"/> | <input type="checkbox"/> | 12. The installer has explained to the customer that a regular maintenance schedule for both the gate and the gate operator is recommended.                                                                                                                                            |

By signing this installation checklist, I/we hereby certify that each item listed and checked above has been covered by the installer and is clearly understood by the customer.

\_\_\_\_\_  
Customer's Signature

\_\_\_\_\_  
Date

\_\_\_\_\_  
Installer's Signature

\_\_\_\_\_  
Date